



Product Catalog

20
25

Product Catalog

Table of Contents



Protective Apparel & Supplies _____ **1**

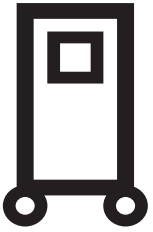

Mobile Barriers _____ **27**

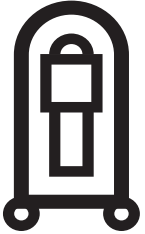

Panel Positioners _____ **29**



Patient Positioners _____ **31**



General Supplies & Accessories _____ **53**

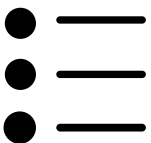

Index _____ **55**

MEASURING MADE EZ.

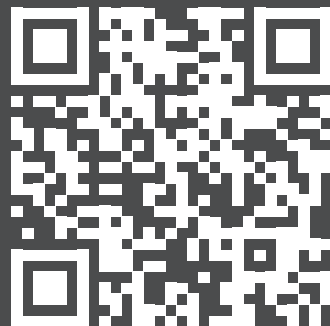
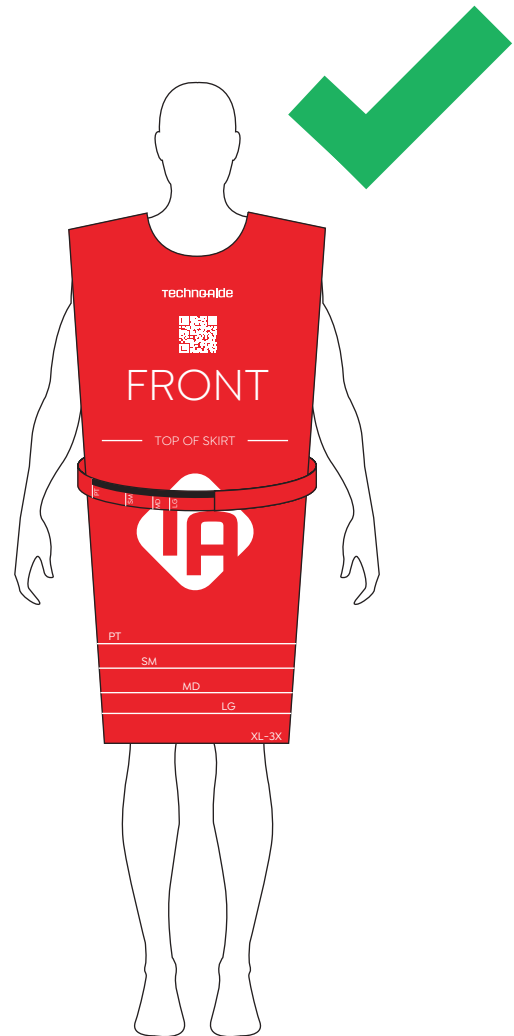
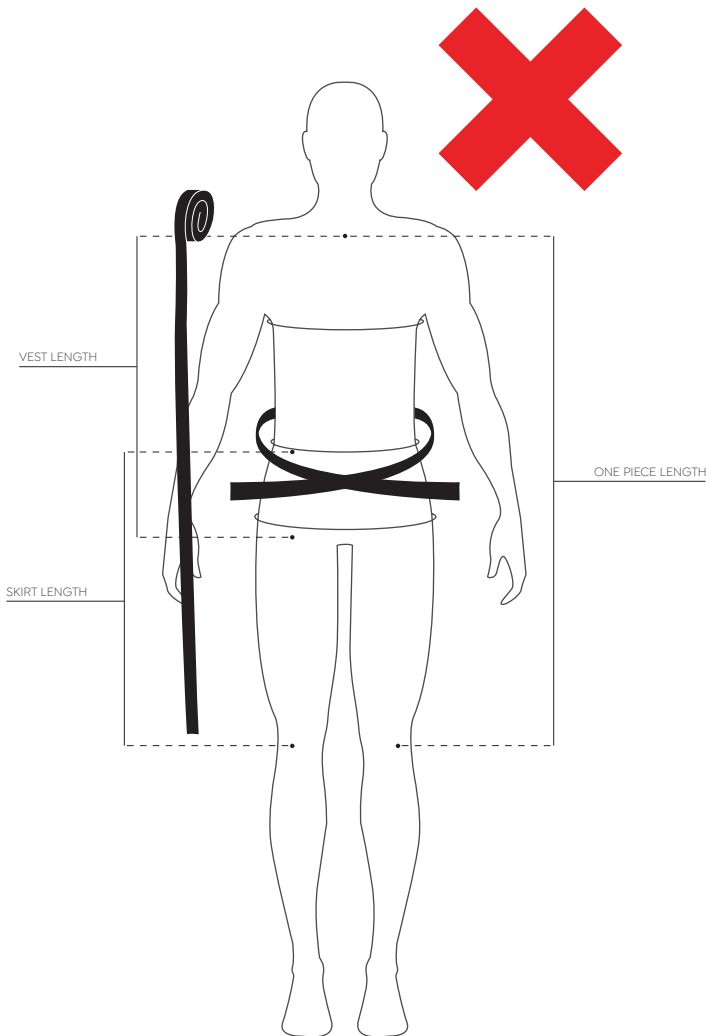

Measuring lead shouldn't be complicated, it should be EZ!
Try our new EZ Fit Apparel Sizing Tool

FREE!

Scan or visit TECHNO-AIDE.com to learn more.

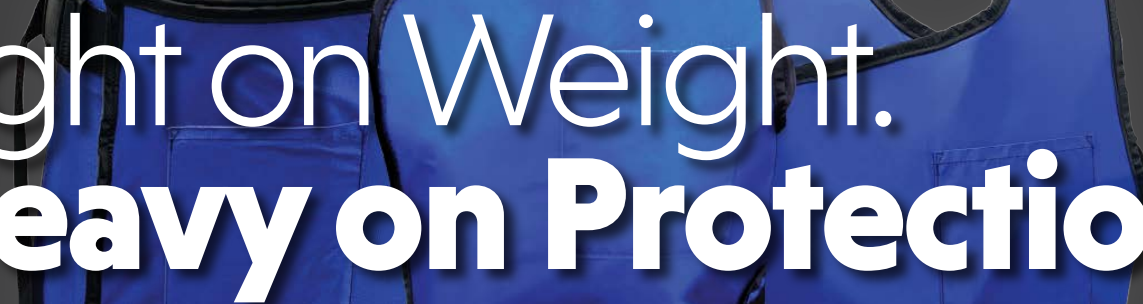

Light on Weight. Heavy on Protection.

Techno-Aide is proud to present our premium selection of lead and lead equivalent core materials. Our apparel is lined with a Bi-Layer core material that has been proven to provide the highest degree of radiation protection while offering the lightest fitting option for healthcare professionals.

MATERIAL	REGULAR LEAD	LIGHTWEIGHT LEAD	LEAD-FREE BILAYER
PROTECTION	0.25mm Pb equivalence: (1-ply) 0.25mm	0.25mm Pb equivalence: (1-ply) 0.25mm	0.25mm Pb equivalence: (1-ply) 0.25mm
	0.35mm Pb equivalence: (2-ply) 0.175mm	0.35mm Pb equivalence: (2-ply) 0.175mm	0.35mm Pb equivalence: (2-ply) 0.175mm
	0.5mm Pb equivalence: (2-ply) 0.25mm	0.5mm Pb equivalence: (2-ply) 0.25mm	0.5mm Pb equivalence: (2-ply) 0.25mm
TRANSMISSIONS	-60 kV 0.25mm: 2.5% 0.35mm: 0.9% 0.5mm: 0.32%	-60 kV 0.25mm: 2.44% 0.35mm: 0.82% 0.5mm: 0.23%	-60 kV 0.25mm: 2.39% 0.35mm: 0.86% 0.5mm: 0.19%
	-90 kV 0.25mm: 8.75% 0.35mm: 4.95% 0.5mm: 2.48%	-90 kV 0.25mm: 8.72% 0.35mm: 4.93% 0.5mm: 2.49%	-90 kV 0.25mm: 8.74% 0.35mm: 4.91% 0.5mm: 2.45%
	-110 kV 0.25mm: 12.69% 0.35mm: 7.67% 0.5mm: 4.39%	-110 kV 0.25mm: 12.67% 0.35mm: 7.65% 0.5mm: 4.38%	-110 kV 0.25mm: 12.60% 0.35mm: 7.63% 0.5mm: 4.36%
ATTENUATION	-60 kV 0.25mm: 97.5% 0.35mm: 99.1% 0.5mm: 99.68%	-60 kV 0.25mm: 97.56% 0.35mm: 99.18% 0.5mm: 99.77%	-60 kV 0.25mm: 97.61% 0.35mm: 99.14% 0.5mm: 99.81%
	-90 kV 0.25mm: 91.25% 0.35mm: 95.05% 0.5mm: 97.52%	-90 kV 0.25mm: 91.28% 0.35mm: 95.07% 0.5mm: 97.51%	-90 kV 0.25mm: 91.26% 0.35mm: 95.09% 0.5mm: 97.55%
	-110 kV 0.25mm: 87.31% 0.35mm: 92.33% 0.5mm: 95.61%	-110 kV 0.25mm: 87.33% 0.35mm: 92.35% 0.5mm: 95.62%	-110 kV 0.25mm: 87.40% 0.35mm: 92.37% 0.5mm: 95.64%
TOLERANCES	-10%/+10%	-7%/+2%	-7%/+2%



EZ FRONT APRON

Lead Options:

- Regular
- Lightweight
- Lead-Free Bilayer

Available in:

- 0.35mm Pb front protection
- 0.5mm Pb front protection

Features:

- Crisscross strap design & shoulder strap for increased comfort
- Unisex Sizing
- Precision-cut necklines & premium shoulder pads for comfort & durability
- Hook & Loop or Buckle Closure (no additional cost)
- Optional embroidery/monogramming (no additional cost; see pg. 23 for details)
- Optional Thyroid buckle tether

0.35mm	Regular	Lightweight	Lead-Free Bilayer
Petite	EP-3R	EP-3L	EP-3N
Small	ES-3R	ES-3L	ES-3N
Medium	EM-3R	EM-3L	EM-3N
Large	EL-3R	EL-3L	EL-3N
X-Large	EX-3R	EX-3L	EX-3N
2XL	E2-3R	E2-3L	E2-3N
3XL	E3-3R	E3-3L	E3-3N
0.5mm	Regular	Lightweight	Lead-Free Bilayer
Petite	EP-5R	EP-5L	EP-5N
Small	ES-5R	ES-5L	ES-5N
Medium	EM-5R	EM-5L	EM-5N
Large	EL-5R	EL-5L	EL-5N
X-Large	EX-5R	EX-5L	EX-5N
2XL	E2-5R	E2-5L	E2-5N
3XL	E3-5R	E3-5L	E3-5N



Front Protection Aprons



EZ COMFORT-FLEX FRONT APRON

Lead Options:

- Regular
- Lightweight
- Super-Lite® Lead-Free

Available in:

- 0.35mm Pb front protection
- 0.5mm Pb front protection

Features:

- Superior flexible crisscross strap design & shoulder strap for increased comfort
- Unisex Sizing
- Precision-cut necklines & premium shoulder pads for comfort & durability
- Hook & Loop or Buckle Closure (no additional cost)
- Optional embroidery/monogramming (no additional cost; see pg. 23 for details)
- Optional Thyroid buckle tether

0.35mm	Regular	Lightweight	Lead-Free Bilayer
Petite	FP-3R	FP-3L	FP-3N
Small	FS-3R	FS-3L	FS-3N
Medium	FM-3R	FM-3L	FM-3N
Large	FL-3R	FL-3L	FL-3N
X-Large	FX-3R	FX-3L	FX-3N
2XL	F2-3R	F2-3L	F2-3N
3XL	F3-3R	F3-3L	F3-3N
0.5mm	Regular	Lightweight	Lead-Free Bilayer
Petite	FP-5R	FP-5L	FP-5N
Small	FS-5R	FS-5L	FS-5N
Medium	FM-5R	FM-5L	FM-5N
Large	FL-5R	FL-5L	FL-5N
X-Large	FX-5R	FX-5L	FX-5N
2XL	F2-5R	F2-5L	F2-5N
3XL	F3-5R	F3-5L	F3-5N



EZ RELEASE SURGERY FRONT APRON

Lead Options:

- Regular
- Lightweight
- Super-Lite® Lead-Free

Available in:

- 0.35mm Pb front protection
- 0.5mm Pb front protection

Features:

- Quick-drop cross-strap design for optional hands-free removal
- Unisex Sizing
- Precision-cut necklines for comfort & durability
- Optional embroidery/monogramming (no additional cost; see pg. 23 for details)
- Optional Thyroid buckle tether

0.35mm	Regular	Lightweight	Lead-Free Bilayer
Petite	UP-3R	UP-3L	UP-3N
Small	US-3R	US-3L	US-3N
Medium	UM-3R	UM-3L	UM-3N
Large	UL-3R	UL-3L	UL-3N
X-Large	UX-3R	UX-3L	UX-3N
2XL	U2-3R	U2-3L	U2-3N
3XL	U3-3R	U3-3L	U3-3N
0.5mm	Regular	Lightweight	Lead-Free Bilayer
Petite	UP-5R	UP-5L	UP-5N
Small	US-5R	US-5L	US-5N
Medium	UM-5R	UM-5L	UM-5N
Large	UL-5R	UL-5L	UL-5N
X-Large	UX-5R	UX-5L	UX-5N
2XL	U2-5R	U2-5L	U2-5N
3XL	U3-5R	U3-5L	U3-5N



Front Protection Aprons



EZ RELEASE COMFORT OR FRONT APRON

Lead Options:

- Regular
- Lightweight
- Lead-Free Bilayer

Available in:

- 0.35mm Pb front protection
- 0.5mm Pb front protection

Features:

- Dual quick-release shoulder straps for shoulder relief and optional hands-free removal
- Unisex Sizing
- Precision-cut necklines & premium shoulder pads for comfort & durability
- Optional embroidery/monogramming (no additional cost; see pg. 23 for details)
- Optional Thyroid buckle tether

0.35mm	Regular	Lightweight	Lead-Free Bilayer
Petite	OP-3R	OP-3L	OP-3N
Small	OS-3R	OS-3L	OS-3N
Medium	OM-3R	OM-3L	OM-3N
Large	OL-3R	OL-3L	OL-3N
X-Large	OX-3R	OX-3L	OX-3N
2XL	O2-3R	O2-3L	O2-3N
3XL	O3-3R	O3-3L	O3-3N
0.5mm	Regular	Lightweight	Lead-Free Bilayer
Petite	OP-5R	OP-5L	OP-5N
Small	OS-5R	OS-5L	OS-5N
Medium	OM-5R	OM-5L	OM-5N
Large	OL-5R	OL-5L	OL-5N
X-Large	OX-5R	OX-5L	OX-5N
2XL	O2-5R	O2-5L	O2-5N
3XL	O3-5R	O3-5L	O3-5N



EZ FULL WRAP VEST

Lead Options:

- Regular
- Lightweight
- Lead-Free Bilayer

Available in:

- 0.35mm Pb front protection & 0.175mm Pb back protection
- 0.5mm Pb front protection & 0.175mm Pb back protection

Features:

- Full panel overlap for complete frontal protection
- Unisex Sizing
- Precision-cut necklines & premium shoulder pads for comfort & durability
- Hook & Loop or Combo Closure (no additional cost)
- Optional embroidery/monogramming (no additional cost; see pg. 23 for details)
- Optional Thyroid buckle tether

0.35mm	Regular	Lightweight	Lead-Free Bilayer
Petite	VP-3R	VP-3L	VP-3N
Small	VS-3R	VS-3L	VS-3N
Medium	VM-3R	VM-3L	VM-3N
Large	VL-3R	VL-3L	VL-3N
X-Large	VX-3R	VX-3L	VX-3N
2XL	V2-3R	V2-3L	V2-3N
3XL	V3-3R	V3-3L	V3-3N
0.5mm	Regular	Lightweight	Lead-Free Bilayer
Petite	VP-5R	VP-5L	VP-5N
Small	VS-5R	VS-5L	VS-5N
Medium	VM-5R	VM-5L	VM-5N
Large	VL-5R	VL-5L	VL-5N
X-Large	VX-5R	VX-5L	VX-5N
2XL	V2-5R	V2-5L	V2-5N
3XL	V3-5R	V3-5L	V3-5N



Front & Back Protection Aprons



EZ FULL WRAP CONTOUR VEST

Lead Options:

- Regular
- Lightweight
- Lead-Free Bilayer

Available in:

- 0.35mm Pb front protection & 0.175mm Pb back protection
- 0.5mm Pb front protection & 0.25mm Pb back protection

Features:

- Improved axillary protection, specifically for women
- Tapered cut for improved weight distribution & comfort
- Less gaping around shoulders & neck
- Hook & Loop or Combo Closure (no additional cost)
- Optional embroidery/monogramming (no additional cost; see pg. 23 for details)
- Optional Thyroid buckle tether

0.35mm	Regular	Lightweight	Lead-Free Bilayer
Petite	XP-3R	XP-3L	XP-3N
Small	XS-3R	XS-3L	XS-3N
Medium	XM-3R	XM-3L	XM-3N
Large	XL-3R	XL-3L	XL-3N
X-Large	XX-3R	XX-3L	XX-3N
2XL	X2-3R	X2-3L	X2-3N
3XL	X3-3R	X3-3L	X3-3N
0.5mm	Regular	Lightweight	Lead-Free Bilayer
Petite	XP-5R	XP-5L	XP-5N
Small	XS-5R	XS-5L	XS-5N
Medium	XM-5R	XM-5L	XM-5N
Large	XL-5R	XL-5L	XL-5N
X-Large	XX-5R	XX-5L	XX-5N
2XL	X2-5R	X2-5L	X2-5N
3XL	X3-5R	X3-5L	X3-5N



EZ REVERSE FULL WRAP VEST

Lead Options:

- Regular
- Lightweight
- Lead-Free Bilayer

Available in:

- 0.35mm Pb front & back protection
- 0.5mm Pb front & back protection

Features:

- Unique reverse wrap design for complete front & back protection
- Unisex Sizing
- Precision-cut necklines & premium shoulder pads for comfort & durability
- Optional embroidery/monogramming (no additional cost; see pg. 23 for details)
- Optional Thyroid buckle tether

0.35mm	Regular	Lightweight	Lead-Free Bilayer
Petite	WP-3R	WP-3L	WP-3N
Small	WS-3R	WS-3L	WS-3N
Medium	WM-3R	WM-3L	WM-3N
Large	WL-3R	WL-3L	WL-3N
X-Large	WX-3R	WX-3L	WX-3N
2XL	W2-3R	W2-3L	W2-3N
3XL	W3-3R	W3-3L	W3-3N
0.5mm	Regular	Lightweight	Lead-Free Bilayer
Petite	WP-5R	WP-5L	WP-5N
Small	WS-5R	WS-5L	WS-5N
Medium	WM-5R	WM-5L	WM-5N
Large	WL-5R	WL-5L	WL-5N
X-Large	WX-5R	WX-5L	WX-5N
2XL	W2-5R	W2-5L	W2-5N
3XL	W3-5R	W3-5L	W3-5N



Front & Back Protection Aprons



EZ PARTIAL OVERLAP VEST

Lead Options:

- Regular
- Lightweight
- Lead-Free Bilayer

Available in:

- 0.35mm Pb front protection & 0.175mm Pb back protection (.75mm Pb equiv. at overlap)
- 0.5mm Pb front protection & 0.25mm Pb back protection (1.00mm Pb equiv. at overlap)

Features:

- Full protection from each front panel and 2x protection at overlap.
- Even weight distribution across waist and hips for extended comfort
- Unisex Sizing
- Optional embroidery/monogramming (no additional cost; see pg. 23 for details)
- Optional Thyroid buckle tether

0.35mm	Regular	Lightweight	Lead-Free Bilayer
Petite	JP-3R	JP-3L	JP-3N
Small	JS-3R	JS-3L	JS-3N
Medium	JM-3R	JM-3L	JM-3N
Large	JL-3R	JL-3L	JL-3N
X-Large	JX-3R	JX-3L	JX-3N
2XL	J2-3R	J2-3L	J2-3N
3XL	J3-3R	J3-3L	J3-3N
0.5mm	Regular	Lightweight	Lead-Free Bilayer
Petite	JP-5R	JP-5L	JP-5N
Small	JS-5R	JS-5L	JS-5N
Medium	JM-5R	JM-5L	JM-5N
Large	JL-5R	JL-5L	JL-5N
X-Large	JX-5R	JX-5L	JX-5N
2XL	J2-5R	J2-5L	J2-5N
3XL	J3-5R	J3-5L	J3-5N



EZ PARTIAL OVERLAP CONTOUR VEST

Lead Options:

- Regular
- Lightweight
- Lead-Free Bilayer

Available in:

- 0.35mm Pb front protection & 0.175mm Pb back protection (.75mm Pb equiv. at overlap)
- 0.5mm Pb front protection & 0.25mm Pb back protection (1.00mm Pb equiv. at overlap)

Features:

- Improved axillary protection, specifically for women
- Tapered cut for improved weight distribution & comfort
- Less gaping around shoulders & neck
- Hook & Loop Closure (no additional cost)
- Optional embroidery/monogramming (no additional cost; see pg. 23 for details)
- Optional Thyroid buckle tether

0.35mm	Regular	Lightweight	Lead-Free Bilayer
Petite	KP-3R	KP-3L	KP-3N
Small	KS-3R	KS-3L	KS-3N
Medium	KM-3R	KM-3L	KM-3N
Large	KL-3R	KL-3L	KL-3N
X-Large	KX-3R	KX-3L	KX-3N
2XL	K2-3R	K2-3L	K2-3N
3XL	K3-3R	K3-3L	K3-3N
0.5mm	Regular	Lightweight	Lead-Free Bilayer
Petite	KP-5R	KP-5L	KP-5N
Small	KS-5R	KS-5L	KS-5N
Medium	KM-5R	KM-5L	KM-5N
Large	KL-5R	KL-5L	KL-5N
X-Large	KX-5R	KX-5L	KX-5N
2XL	K2-5R	K2-5L	K2-5N
3XL	K3-5R	K3-5L	K3-5N



Front & Back Protection Aprons



EZ FULL WRAP SKIRT

Lead Options:

- Regular
- Lightweight
- Lead-Free Bilayer

Available in:

- 0.35mm Pb front protection & 0.175mm Pb back protection
- 0.5mm Pb front protection & 0.25mm Pb back protection

Features:

- Full panel overlap for complete frontal protection
- Even weight distribution across waist and hips for extended comfort
- Unisex Sizing
- Combo Closure (no additional cost)
- Optional embroidery/monogramming (no additional cost; see pg. 23 for details)

0.35mm	Regular	Lightweight	Lead-Free Bilayer
Petite	SP-3R	SP-3L	SP-3N
Small	SS-3R	SS-3L	SS-3N
Medium	SM-3R	SM-3L	SM-3N
Large	SL-3R	SL-3L	SL-3N
X-Large	SX-3R	SX-3L	SX-3N
2XL	S2-3R	S2-3L	S2-3N
3XL	S3-3R	S3-3L	S3-3N
0.5mm	Regular	Lightweight	Lead-Free Bilayer
Petite	SP-5R	SP-5L	SP-5N
Small	SS-5R	SS-5L	SS-5N
Medium	SM-5R	SM-5L	SM-5N
Large	SL-5R	SL-5L	SL-5N
X-Large	SX-5R	SX-5L	SX-5N
2XL	S2-5R	S2-5L	S2-5N
3XL	S3-5R	S3-5L	S3-5N



EZ FULL WRAP APRON

Lead Options:

- Lightweight
- Lead-Free Bilayer

Available in:

- 0.35mm Pb front protection & 0.175mm Pb back protection
- 0.5mm Pb front protection & 0.25mm Pb back protection

Features:

- Full panel overlap for complete frontal protection
- Combo closure (hook & loop and buckle) design for even weight distribution across shoulders, waist, and hips
- Unisex Sizing
- Precision-cut necklines & premium shoulder pads for comfort & durability
- Optional embroidery/monogramming (no additional cost; see pg. 23 for details)
- Optional Thyroid buckle tether

0.35mm	Lightweight	Lead-Free Bilayer
Petite	MP-3L	MP-3N
Small	MS-3L	MS-3N
Medium	MM-3L	MM-3N
Large	ML-3L	ML-3N
X-Large	MX-3L	MX-3N
2XL	M2-3L	M2-3N
3XL	M3-3L	M3-3N
0.5mm	Lightweight	Lead-Free Bilayer
Petite	MP-5L	MP-5N
Small	MS-5L	MS-5N
Medium	MM-5L	MM-5N
Large	ML-5L	ML-5N
X-Large	MX-5L	MX-5N
2XL	M2-5L	M2-5N
3XL	M3-5L	M3-5N



Thyroid Protection

Techno-Aide's **Standard Thyroid Shields** are a convenient and cost-effective solution for thyroid protection. Thyroid Shields feature a simple one-size-fits-all design and precision-cut comfort necklines. Available in three styles to meet virtually any need: top and bottom "Full Binding", bottom only "Mid-Binding", or premium "No Binding." All Thyroid Shields are available with either **0.5mm Pb** or **0.35mm Pb equivalent protection**, and your choice of three media options: Regular Lead, Lightweight Lead (composite) or our premium Lead-Free Bilayer. All Standard Thyroid Shields include free embroidery/monogramming (see pg. 23 for details) and a convenient buckle tether.

– Choose from 3 **FREE** closure options: Buckle, Hook & Loop, or Magnetic –

FULL BINDING

0.35mm	Regular	Lightweight	Lead-Free Bilayer
Buckle	TS-3R-B	TS-3L-B	TS-3N-B
Hook & Loop	TS-3R-V	TS-3L-V	TS-3N-V
Magnetic	TS-3R-M	TS-3L-M	TS-3N-M
0.5mm	Regular	Lightweight	Lead-Free Bilayer
Buckle	TS-5R-B	TS-5L-B	TS-5N-B
Hook & Loop	TS-5R-V	TS-5L-V	TS-5N-V
Magnetic	TS-5R-M	TS-5L-M	TS-5N-M



MID-BINDING

0.35mm	Regular	Lightweight	Lead-Free Bilayer
Buckle	TH-3R-B	TH-3L-B	TH-3N-B
Hook & Loop	TH-3R-V	TH-3L-V	TH-3N-V
Magnetic	TH-3R-M	TH-3L-M	TH-3N-M
0.5mm	Regular	Lightweight	Lead-Free Bilayer
Buckle	TH-5R-B	TH-5L-B	TH-5N-B
Hook & Loop	TH-5R-V	TH-5L-V	TH-5N-V
Magnetic	TH-5R-M	TH-5L-M	TH-5N-M



NO BINDING

0.35mm	Regular	Lightweight	Lead-Free Bilayer
Buckle	TN-3R-B	TN-3L-B	TN-3N-B
Hook & Loop	TN-3R-V	TN-3L-V	TN-3N-V
Magnetic	TN-3R-M	TN-3L-M	TN-3N-M
0.5mm	Regular	Lightweight	Lead-Free Bilayer
Buckle	TN-5R-B	TN-5L-B	TN-5N-B
Hook & Loop	TN-5R-V	TN-5L-V	TN-5N-V
Magnetic	TN-5R-M	TN-5L-M	TN-5N-M





Techno-Aide is proud to offer two **Specialty Thyroid Shields** styles to help meet unique patient needs. These Specialty Thyroid Shield styles feature a simple one-size-fits-all design and precision-cut comfort necklines. Specialty Thyroid Shields feature **0.5mm Pb equivalent protection**, and your choice of three media options: Regular Lead, Lightweight Lead (composite) or our premium Lead-Free Bilayer. All Specialty Thyroid Shields include free embroidery/monogramming (see pg. 23 for details).

MAMMOGRAPHY

0.5mm	Regular	Lightweight	Lead-Free Bilayer
Mammo	TM-5R	TM-5L	TM-5N

Techno-Aide's **Mammography Thyroid Shields** feature a premium "No Binding" style for maximum comfort. Designed for use in mammography studies, the short bib protects the patient's thyroid without interfering with the mammography image.



PEDIATRIC

0.5mm	Regular	Lightweight	Lead-Free Bilayer
Pediatric	TP-5R	TP-5L	TP-5N

Techno-Aide's **Pediatric Thyroid Shields** are designed for use in pediatric studies. The one-size-fits-all design and compact bib are perfect for adolescent patients of virtually any age.



All **FULL, MID, and NO BINDING** Thyroid Guards include the option of a **FREE** buckle tether!



Apparel Embroidery

Techno-Aide is proud to offer **FREE** embroidery/monogramming services for all protective apparel products.

Aprons include the following embroidery/monogramming options:

Embroidered Logo on Pockets (One-Time Digitizing Fee May Apply)

Up to 2 Lines of Embroidery - 26 Characters Per Line

EMBROIDERY STYLES

STANDARD BLOCK

Sample

ALL CAPS

SAMPLE

SCRIPT

Sample

EMBROIDERY THREAD OPTIONS:



EMBROIDERY LOCATIONS

APRONS/VESTS



SKIRTS



THYROIDS

UP TO 2 LINES
26 CHARACTERS PER LINE

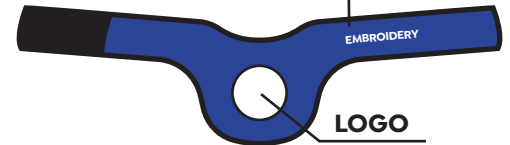

INTERCHANGEABLE NAME TAG



Name Tags include the following embroidery options:

Up to 2 Lines of Embroidery - 26 Characters Per Line

Styles: Standard Block, All Caps



STANDARD SOLID

Lightweight, liquid repellent, filament reinforced fabric



COMFORT SOLID

Ultra-smooth, lightweight, liquid repellent, filament reinforced fabric



BINDING COLORS

Lightweight, liquid repellent, durable binding

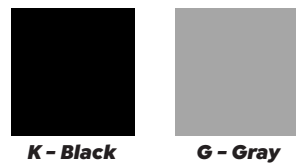

REINFORCED RIPSTOP

Med. weight, liquid repellent, deluxe filament reinforced fabric



PRINTS & PATTERNS

Medium weight, liquid repellent, deluxe filament patterned fabric



SHOPPING WITH TECHNO-AIDE IS EASY AS 1-2-3

1. Choose the perfect style & design.
2. Enter your favorite fabric color code.
3. Enter your favorite binding color code.

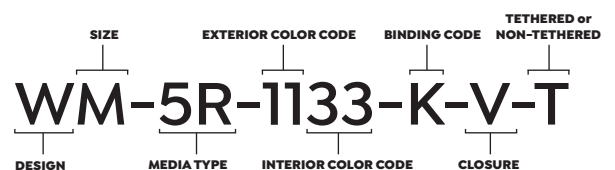

EXAMPLE - EZ Reverse Vest - Medium | 0.5 Pb EQ | Regular Lead | 11-Royal Blue, 33-Black | Black Binding | Hook & Loop | Thyroid Tether



Techno-Aide's **EZ Fit Sizing Tool** quickly and accurately fits people into the perfect Techno-Aide apron size without the need for measuring tapes. However, use these measuring charts to verify your fit if a measuring tape is the only available option.

Techno-Aide standard aprons (front, full wrap, vests, & skirts) are fit using two measurements:

- **Width** measured at the **widest point of the body** applicable to apron style
- **Length** measured applicable to apron style

Visit Techno-Aide.com/ez-fit-sizing-tool for step-by-step measuring instructions and to order your sizing tool today!

FRONT APRONS

Measurement	Petite	Small	Medium	Large	X-Large	2XL	3XL
Chest Circumference	32-35.5"	35.5-38.5"	38.5-40"	40-46"	46-51"	51-55"	55-60"
Length (from Sternal Notch)	33.5"	35.25"	37.25"	39.75"	41.5"	41.5"	41.75"
Width (at widest point)	20.25"	22.75"	23.5"	24.5"	26.5"	29"	32.5"

EZ FULL WRAP & PARTIAL OVERLAP VESTS

Measurement	Petite	Small	Medium	Large	X-Large	2XL	3XL
Chest Circumference	32-35.5"	35.5-38.5"	38.5-40"	40-46"	46-51"	51-55"	55-60"
Length (from Sternal Notch)	21"	22"	22.5"	24"	25"	26"	26"
Width (at widest point)	17.5"	18.5"	19.5"	21"	24.5"	27"	29"

EZ CONTOUR & PARTIAL OVERLAP CONTOUR VESTS

Measurement	Petite	Small	Medium	Large	X-Large	2XL	3XL
Chest Circumference	32-35.5"	35.5-38.5"	38.5-40"	40-46"	46-51"	51-55"	55-60"
Length (from Sternal Notch)	21"	22"	22.5"	24"	25"	26"	26"
Width (at widest point)	17.5"	18.5"	19.5"	21"	24.5"	27.5"	29.5"

EZ REVERSE FULL WRAP VESTS

Measurement	Petite	Small	Medium	Large	X-Large	2XL	3XL
Chest Circumference	32-35.5"	35.5-38.5"	38.5-40"	40-46"	46-51"	51-55"	55-60"
Length (from Sternal Notch)	18.5"	21.5"	22"	23.25"	23"	24"	23.5"
Width (at widest point)	21"	20"	23"	24.25"	26.5"	29.5"	31.5"

FULL WRAP SKIRTS

Measurement	Petite	Small	Medium	Large	X-Large	2XL	3XL
Waist Circumference	25-27"	28-30"	31-33"	34-35"	36-40"	41-43"	44-46"
Length (top to bottom)	19"	19.5"	20"	21"	22"	22.5"	22.5"
Hips Circumference	31"	38"	39"	40"	41"	46"	50"

FULL WRAP APRONS

Measurement	Petite	Small	Medium	Large	X-Large	2XL	3XL
Chest Circumference	32-35.5"	35.5-38.5"	38.5-40"	40-46"	46-51"	51-55"	55-60"
Length (from Sternal Notch)	36"	37"	38.5"	40.5"	43"	44"	44"
Width (at widest point)	18.5"	19.5"	20.5"	22.5"	25.5"	28.5"	30.5"



LAP GUARD HALF APRONS

Measurement	Petite	Small	Medium	Large	X-Large	2XL
Width (at widest point)	10"	12"	20.5"	24"	24"	36"
Length (top to bottom)	10"	12"	16"	17"	18.5"	19.5"

BLANKET GUARDS

Measurement	Small	Medium	Large	X-Large
Width (side to side)	18"	24"	24"	24"
Length (top to bottom)	18"	24"	36"	48"

PREGNANCY FRONT APRONS

Measurement	Standard	Full
Width (at chest)	30"	34"
Length (from shoulders)	43"	45"

PREGNANCY HALF APRONS

Measurement	Standard
Width (at hips)	27"
Length (from waist)	27"

GONADAL GUARDS

Measurement	Small	Medium	Large
Width (side to side)	4"	6"	7.5"
Length (top to bottom)	6"	7"	9"
Strap Length	8-61"	8-61"	8-61"

BREAST GUARDS

Measurement	Child	Adult
Width (side to side)	5"	6"
Length (top to bottom)	6"	7"
Strap Length	8-36"	8-36"

THYROID GUARDS

Measurement	Standard	Mammo	Pediatric
Length (strap to strap)	24"	24"	16"
Bib Height	5.75"	4.75"	4"

PEDIATRIC FRONT APRONS

Measurement	Standard
Width (at waist)	18"
Length (from shoulders)	25.68"

DENTAL DRAPES

Measurement	Child	Adult
Width (at widest point)	18"	23.5"
Length (from neckline)	23.7"	28.4"
Back Flaps (from shoulders)	7.5"	11.5"

PANORAMIC DENTAL DRAPES

Measurement	Adult
Front Width (at widest point)	24"
Front Length (from neckline)	26"
Back Width (at widest point)	25"
Back Length (from neckline)	15.5"

SCOLIO GUARDS

Measurement	Standard
Width (side to side)	8"
Length (top to bottom)	26"
Neck Strap	8-36"
Waist Strap	49"

SIZING TOOL VIDEO





Techno-Aide is proud to offer our unique line of **General and Specialty Protective Apparel**. This diverse line of products and accessories are specially curated to help meet a variety of unique patient and facility needs.

LAP GUARD HALF APRONS

0.35mm	Regular	Lightweight	Lead-Free Bilayer
Petite	LP-3R	LP-3L	LP-3N
Small	LS-3R	LS-3L	LS-3N
Medium	LM-3R	LM-3L	LM-3N
Large	LL-3R	LL-3L	LL-3N
X-Large	LX-3R	LX-3L	LX-3N
2XL	L2-3R	L2-3L	L2-3N
0.5mm	Regular	Lightweight	Lead-Free Bilayer
Petite	LP-5R	LP-5L	LP-5N
Small	LS-5R	LS-5L	LS-5N
Medium	LM-5R	LM-5L	LM-5N
Large	LL-5R	LL-5L	LL-5N
X-Large	LX-5R	LX-5L	LX-5N
2XL	L2-5R	L2-5L	L2-5N



Techno-Aide is proud to offer our **Lap Guard Half Apron Bundles**. These prebuilt bundles are a convenient and quick way to outfit virtually any imaging facility. Each bundle includes four color-coded lap guard half apron sizes and a low-profile apron storage rack. Available with your choice of hook & loop or buckle closures and free embroidery.

LAP GUARD HALF APRON BUNDLES

Included Products:

- S** Lap Guard Half Apron - **Berry** - 0.5mm Pb Reg. Lead
- M** Lap Guard Half Apron - **Gray** - 0.5mm Pb Reg. Lead
- L** Lap Guard Half Apron - **Royal Blue** - 0.5mm Pb Reg. Lead
- XL** Lap Guard Half Apron - **Black** - 0.5mm Pb Reg. Lead
- Wall Mounted Storage Rack** - 2 Pegs [white]

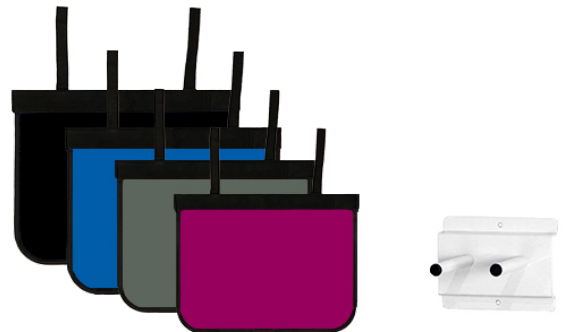

SKU	Buckle	Hook & Loop	Embroidery
LAP-BNDL-B	✓		
LAP-BNDL-B-E	✓		✓
LAP-BNDL-V		✓	
LAP-BNDL-V-E		✓	✓



BLANKET GUARDS

0.35mm	Regular	Lightweight	Lead-Free Bilayer
Small	AS-3R	AS-3L	AS-3N
Medium	AM-3R	AM-3L	AM-3N
Large	AL-3R	AL-3L	AL-3N
X-Large	AX-3R	AX-3L	AX-3N
0.5mm	Regular	Lightweight	Lead-Free Bilayer
Small	AS-5R	AS-5L	AS-5N
Medium	AM-5R	AM-5L	AM-5N
Large	AL-5R	AL-5L	AL-5N
X-Large	AX-5R	AX-5L	AX-5N

GONADAL GUARDS

0.5mm	Regular	Lightweight	Lead-Free Bilayer
Small	GS-5R	GS-5L	GS-5N
Medium	GM-5R	GM-5L	GM-5N
Large	GL-5R	GL-5L	GL-5N
Bundles	GB-5R (1 ea.)	GB-5L (1 ea.)	GB-5N (1 ea.)

BREAST GUARDS

0.5mm	Regular	Lightweight	Lead-Free Bilayer
Child	BC-5R	BC-5L	BC-5N
Adult	BA-5R	BA-5L	BA-5N

PREGNANCY FRONT APRONS

1.0mm	Lightweight	Lead-Free Bilayer
Standard	PS-1L	PS-1N
Full	PT-1L	PT-1N

EZ DENTAL DRAPES

0.35mm	Regular	Lightweight	Lead-Free Bilayer
Child	DC-3R	DC-3L	DC-3N
Adult	DA-3R	DA-3L	DA-3N

PREGNANCY LAP GUARD HALF APRONS

1.0mm	Lightweight	Lead-Free Bilayer
Standard	RX-1L	RX-1N

EZ PANORAMIC DENTAL DRAPES

0.35mm	Regular	Lightweight	Lead-Free Bilayer
Adult	NA-3R	NA-3L	NA-3N

EZ PEDIADTRIC FRONT APRON

0.5mm	Regular	Lightweight	Lead-Free Bilayer
Child	CC-5R	CC-5L	CC-5N

SCOLIO GUARDS

0.5mm	Regular
Standard	IS-5R

EZ CAP

2.0mm	Lead-Free Bilayer
Small	QS-2N
Medium	QM-2N
Large	QL-2N



EZ SLEEVE

0.25mm	Lead-Free Bilayer
Standard	HO-2N-33-K-V-N





STERILE RADIATION PROTECTION SURGICAL GLOVES



Free Guard

- Unmatched dexterity, comfort, and fingertip sensitivity
- Meets FDA standards for medical use in operating environments

Model 1 Free Guard	Size 6	Size 6.5	Size 7	Size 7.5	Size 8	Size 8.5	Size 9
Box (5 Pairs)	Model160-BK	Model165-BK	Model170-BK	Model175-BK	Model180-BK	Model185-BK	Model190-BK
Case (10 Boxes)	Model160-CS	Model165-CS	Model170-BK	Model175-BK	Model180-BK	Model185-BK	Model190-BK
Model 2 Free Guard	Size 6	Size 6.5	Size 7	Size 7.5	Size 8	Size 8.5	Size 9
Case (10 Boxes)	Model260-CS	Model265-CS	Model270-BK	Model275-BK	Model280-BK	Model285-BK	Model290-BK



X Guard

- Unmatched dexterity, comfort, and fingertip sensitivity
- Meets FDA standards for medical use in operating environments

RR1 XGuard	Size 6	Size 6.5	Size 7	Size 7.5	Size 8	Size 8.5	Size 9
Box (5 Pairs)	RR160-BK	RR165-BK	RR170-BK	RR175-BK	RR180-BK	RR185-BK	RR190-BK
Case (10 Boxes)	RR160-CS	RR165-CS	RR170-BK	RR175-BK	RR180-BK	RR185-BK	RR190-BK
RR2 XGuard	Size 6	Size 6.5	Size 7	Size 7.5	Size 8	Size 8.5	Size 9
Case (10 Boxes)	RR260-CS	RR265-CS	RR270-CS	RR275-CS	RR280-CS	RR285-CS	RR290-CS
RR3 XGuard	Size 6	Size 6.5	Size 7	Size 7.5	Size 8	Size 8.5	Size 9
Case (10 Boxes)	RR360-CS	RR365-CS	RR370-CS	RR375-CS	RR380-CS	RR385-CS	RR390-CS

RADIATION PROTECTION GLOVES



100V-DKB - Premium Full Coverage Radiation Safety Finger Gloves (Single Pair)



101SLMIT-DKB - Premium Full Coverage Radiation Safety Mitts w/ Dexterity Palm Slit (Single Pair)

- Seamless lead-lined vinyl fabric with a dip molded core, offering full 0.5mm Pb equivalency protection

AVAILABLE BRANDS



RUGGED RADIATION SAFETY GLASSES



RG-1205-BK



RG-1205-BL

ULTRA-GUARD RADIATION SAFETY GLASSES



RG-208-BK



RG-208-S

ECONOMY RADIATION SAFETY GLASSES



RG-F10-BB-50SS



RG-F10-BY-50SS



RG-F10-CLR-50SS



RG-F126-BK-50SS

PREMIUM RADIATION SAFETY GLASSES



RG-15011-BKY-50SS



RG-15011-CB-50SS



RG-15011-CC-50SS



RG-15011-CP-50SS



RG-15011-NVC-50SS

CONVERTIBLE RADIATION SAFETY GLASSES



RG-Q100-BK-50SS



RG-Q200-BLPK-50SS



RG-Q200-PUR-50SS



RG-Q200-BK-50SS



RG-Q300-BK-50SS

NAME BRAND RADIATION SAFETY GLASSES



RG-NI-FJ1975-010



RG-NI-FJ1975-021



RG-NI-FJ1978-451



RG-NI-FJ1978-451



RG-RB2132-902L-55



RG-NI-FJ1985-010



RG-NI-FJ1985-060



RG-NI-DV2152-010



RG-NI-DV2155-010



RG-OO9102-3655

Now offering prescription lenses for all glasses!

Visit Techno-Aide.com today to shop all of our products and services!



APRON PEG RACKS



ARP-02-61



ARP-06-61



ARP-08-61

SKU	Part Description
ARP-02-61	Wall Mounted Storage Rack - 2 Pegs 7.5 x 7.5 6 [White]
ARP-06-61	Wall Mounted Storage Rack - 6 Pegs 28.5 x 7.5 6 [White]
ARP-06-61	Wall Mounted Storage Rack - 8 Pegs 28.5 x 7.5 6 [White]

APRON HANGING RACKS



AGR-110



AGR-105

SKU	Part Description
AGR-105	Wall Mounted Apron Hanging Rack - 29 x 7 x 6.5 (L x W x H) [White]
AGR-110	Wall Mounted Apron Hanging Rack - 29 x 7 x 18 (L x W x H) [White]

SWING-ARM APRON RACKS



ARW-10



ARW-R5

ARW-L5

SKU	Part Description
ARW-L5	Wall Mounted Swing-Arm Apron Rack - 5 Arm (Swing Left) [White]
ARW-R5	Wall Mounted Swing-Arm Apron Rack - 5 Arm (Swing Right) [White]
ARW-10	Wall Mounted Swing-Arm Apron Rack - 5 Arm (Swing L & R) [White]



MOBILE SWING-ARM APRON RACKS



ARM-100



ARM-R5



ARM-L5

SKU	Part Description
ARM-L5	Mobile Swing-Arm Apron Rack - 5-Arm (Swing Left) [White]
ARM-R5	Mobile Swing-Arm Apron Rack - 5-Arm (Swing Right) [White]
ARM-100	Mobile Swing-Arm Apron Rack - 10-Arm (Swing L & R) [White]
ARM-G60	Mobile Swing-Arm Apron Rack - 10-Arm (Swing L & R) w/ 6 Glove Holders [White]

Z-STORAGE RACK



H1978BL



H1978BL10

SKU	Part Description
H1978BL	Mobile Z-Base Apron Storage Rack [Black]
H1978BL10	Mobile Z-Base Apron Storage Rack w/ 10 Steel Apron Hangers [Black]

STEEL APRON HANGERS

SKU	Part Description
ARH-01	Steel Apron Hanger (Single)
ARH-10	Steel Apron Hanger (QTY of 10)



APRON MANAGEMENT

APRON TAGS

SKU	Part Description
AHDT23	Apparel 2023 Date Tags - Gray (Pack of 50)
AHDT24	Apparel 2024 Date Tags - Pink (Pack of 50)
AHDT25	Apparel 2025 Date Tags - Red (Pack of 50)
AHR24	Apparel Date Ring 2024 - White
AHR25	Apparel Date Ring 2025 - Red
AQRT	ApronHub Adhesive QR Tag
500249	Apron-Hub QR Serial Number Labels (Single Roll of 100 Labels)

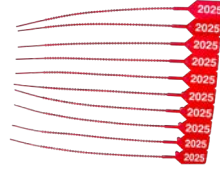

AHDT25



AHR25



AQRT



500249

APRON RECYCLING

Techno-Aide's unique partnership with world renowned transitional company *Veolia*®, allows us to offer a one-of-a-kind, on-demand, lead apron recycling program. This revolutionary program provides health care facilities of virtually any size, a quick and cost-effective way to dispose of lead and/or lead-equivalent garments properly and safely!

Visit **Techno-Aide.com** for more information!

SKU	Part Description
RPAK1	Protective Apparel Recycling Box - (1 Single Box)
RPAK5	Protective Apparel Recycling Box - (5 Boxes)



APRON·HUB

Techno-Aide's revolutionary **FREE** lead tracking system. Now with built-in SmartID® data import capability!

WEB-BASED ACCESS

from any device.

UNIVERSALLY COMPATIBLE

with any QR/Barcode Scanner.

ACCOUNT CUSTOMIZATION TOOLS

to meet the specific needs of your department.

CUSTOM REPORTING

makes exporting inventory data specific and easy.

MASS IMPORTING OPTION

to make switching from any platform a streamlines process.

DIGITAL RETAGGING

features a first-time tool built right into each product page to allow for seamless apron retagging.

CLOUD-BASED SECURITY

for built in scale no matter how big your organization becomes.

ABSOLUTELY FREE!

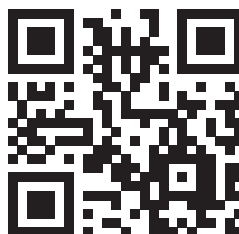
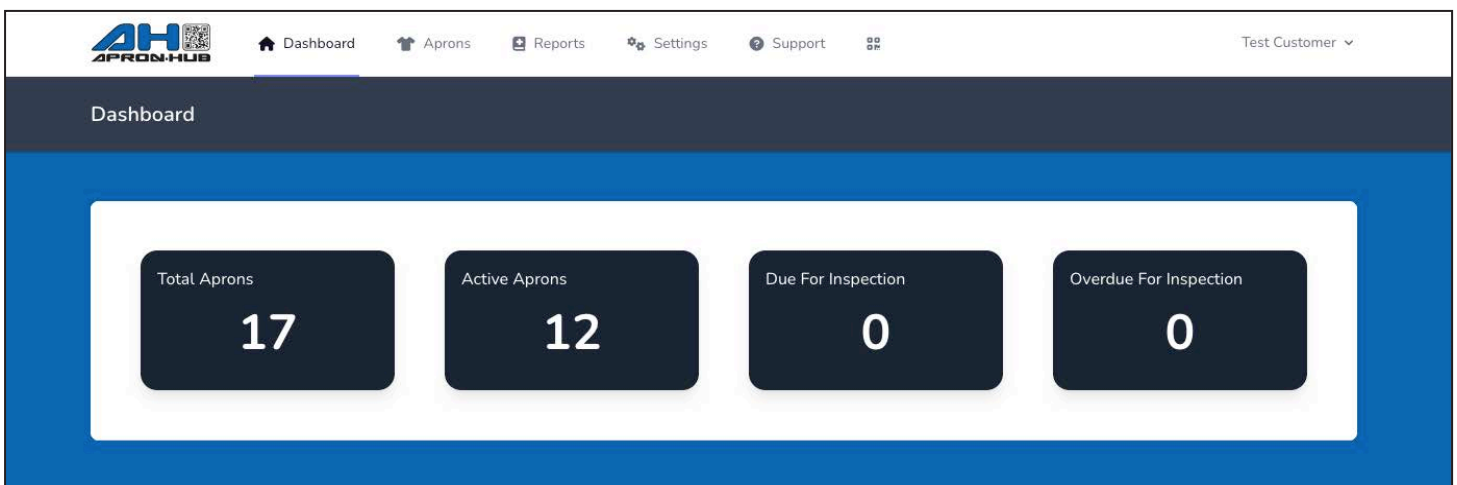



STANDARD MOBILE BARRIERS



MB2430G20



LB-3048



LB-3060



LB-3036

SKU	Part Description
MB2430G20	Standard Leaded Glass Mobile Barrier [30 x 24 Leaded Window 33 x 75 Overall Size]
LB-3048	Standard Leaded Glass Mobile Barrier [30 x 48 Leaded Window 33 x 75 Overall Size]
LB-3060	Standard Leaded Glass Mobile Barrier [30 x 60 Leaded Window 33 x 75 Overall Size]
LB-3036	Standard Leaded Glass Mobile Barrier [36 x 30 Leaded Window 33 x 75 Overall Size]

COMPACT WINDOW MOBILE BARRIERS



LB-1012-2472



LB-1012-3072



LB-1012-3672

SKU	Part Description
LB-1012-2472	Compact Window Leaded Glass Mobile Barrier [12 x 10 Leaded Window 24 x 72 Overall Size]
LB-1012-3072	Compact Window Leaded Glass Mobile Barrier [12 x 10 Leaded Window 30 x 72 Overall Size]
LB-1012-3672	Compact Window Leaded Glass Mobile Barrier [12 x 10 Leaded Window 36 x 72 Overall Size]

SPECIALTY/ADJUSTABLE MOBILE BARRIERS



LB-3648



LB-3672



LB-7429

SKU	Part Description	SKU	Part Description
LB-3648	Specialty Leaded Glass Mobile Barrier [36 x 48 Leaded Window 52.5 x 75 Overall Size]	LB-7429	Adjustable Height Leaded Glass Mobile Barrier [24 x 24 Leaded Window 31 x 41 Opaque Panel 31 x 70 Overall Size]
LB-3672	Specialty Leaded Glass Mobile Barrier [36 x 72 Leaded Window 75.5 x 75 Overall Size]		



MOBILE SHIELDS

SKU	Part Description
LPS-S2424	Economy Star-Base Mobile Shield [24 x 24/0.5mm Regular Lead/5-Star Base]
LPS-S2436	Economy Star-Base Mobile Shield [24 x 36/0.5mm Regular Lead/5-Star Base]
LPS-S2448	Economy Star-Base Mobile Shield [24 x 48/0.5mm Regular Lead/5-Star Base]
LPSG-S2424	Economy Star-Base Mobile Shield [24 x 24/0.5mm Super-Lite® Lead-Free/5-Star Base]
LPSG-2436	Economy Star-Base Mobile Shield [24 x 36/0.5mm Super-Lite® Lead-Free/5-Star Base]
LPSG-2448	Economy Star-Base Mobile Shield [24 x 48/0.5mm Super-Lite® Lead-Free/5-Star Base]
LPS-T2424S	Standard T-Base Mobile Shield [24 x 24/0.5mm Regular Lead/T-Base]
LPS-T2430S	Standard T-Base Mobile Shield [24 x 30/0.5mm Regular Lead/T-Base]
LPS-T2436S	Standard T-Base Mobile Shield [24 x 36/0.5mm Regular Lead/T-Base]
LPS-T2448S	Standard T-Base Mobile Shield [24 x 48/0.5mm Regular Lead/T-Base]
LPS-T3030S	Standard T-Base Mobile Shield [30 x 30/0.5mm Regular Lead/T-Base]
LPS-T3036S	Standard T-Base Mobile Shield [30 x 36/0.5mm Regular Lead/T-Base]
LPS-T3042S	Standard T-Base Mobile Shield [30 x 42/0.5mm Regular Lead/T-Base]
LPS-H3636	Premium H-Base Mobile Shield [36 x 36/0.5mm Regular Lead/H-Base]
LPS-H3648	Premium H-Base Mobile Shield [36 x 48/0.5mm Regular Lead/H-Base]
LPS-H4848	Premium H-Base Mobile Shield [48 x 48/0.5mm Regular Lead/H-Base]



5-Star Base

T-Base

H-Base

All Mobile Shields include optional **FREE** embroidery!

LEADED TABLE DRAPES

SKU	Part Description
TDI-18-11	Leaded Table Drape - Single 18" x 12" Panel (L x W) 0.5mm Regular Lead 11-Royal Blue
TDI-18-33	Leaded Table Drape - Single 18" x 12" Panel (L x W) 0.5mm Regular Lead 33-Black
TDI-24-11	Leaded Table Drape - Single 24" x 12" Panel (L x W) 0.5mm Regular Lead 11-Royal Blue
TDI-24-33	Leaded Table Drape - Single 24" x 12" Panel (L x W) 0.5mm Regular Lead 33-Black
TDI-30-11	Leaded Table Drape - Single 30" x 12" Panel (L x W) 0.5mm Regular Lead 11-Royal Blue
TDI-30-33	Leaded Table Drape - Single 30" x 12" Panel (L x W) 0.5mm Regular Lead 33-Black
TDI-36-11	Leaded Table Drape - Single 36" x 12" Panel (L x W) 0.5mm Regular Lead 11-Royal Blue
TDI-36-33	Leaded Table Drape - Single 36" x 12" Panel (L x W) 0.5mm Regular Lead 33-Black
TL-1-24	Table Drape Adhesive Table Liner - Single 24" x 11" Strip (L x W) [Black]
TL-1-48	Table Drape Adhesive Table Liner - Single 48" x 12" Strip (L x W) [Black]
TDHS	Table Drape Hanging Straps - Set of 2 (8" Hook & Loop Straps) [Black]



Table Drapes



Table Drapes with Liner



Table Drapes with Straps



MOBILE PANEL HOLDERS



MCH-33B - Mobile Tilt & Rotate CR/DR Panel Holder (Vertical Clamp)



MCH-33C - Mobile Tilt & Rotate CR/DR Panel Holder (Horizontal Clamp)



MCH-37B - Mobile Full Motion CR/DR Panel Holder (Vertical Clamp)



MCH-37C - Mobile Full Motion CR/DR Panel Holder (Horizontal Clamp)



DR.LNS1417LDWD - 14"x17" Lock-N-Secure with Side Handle & Carbon Fiber Insert



DR.LNS1417SD2WD - 14"x17" Lock-N-Secure Short Dimension Handle & Carbon Fiber Insert



DR.LNS1717WD - 17"x17" Lock-N-Secure Panel Protector & Carbon Fiber Insert

SIDEKICK by TechnoAide

A Mobile Positioning Companion for Mobile DR

With **powered vertical and horizontal travel**, plus **powered tilt and pivot motions**, let the Sidekick do all the work for you. No more awkward adjustments being made within the personal space of your patient, or valuable time being spent fine tuning without visibility of your frame of reference. Position your Sidekick with the press of a button!

- Wireless remote controlled motion
- Actuator-driven vertical and horizontal motions
- Actuator-driven panel tilt and pivot motions
- Coarse and fine adjustment settings
- Ergonomic panel loading and unloading
- Sanitizer and disinfectant resistant surface
- Locking casters

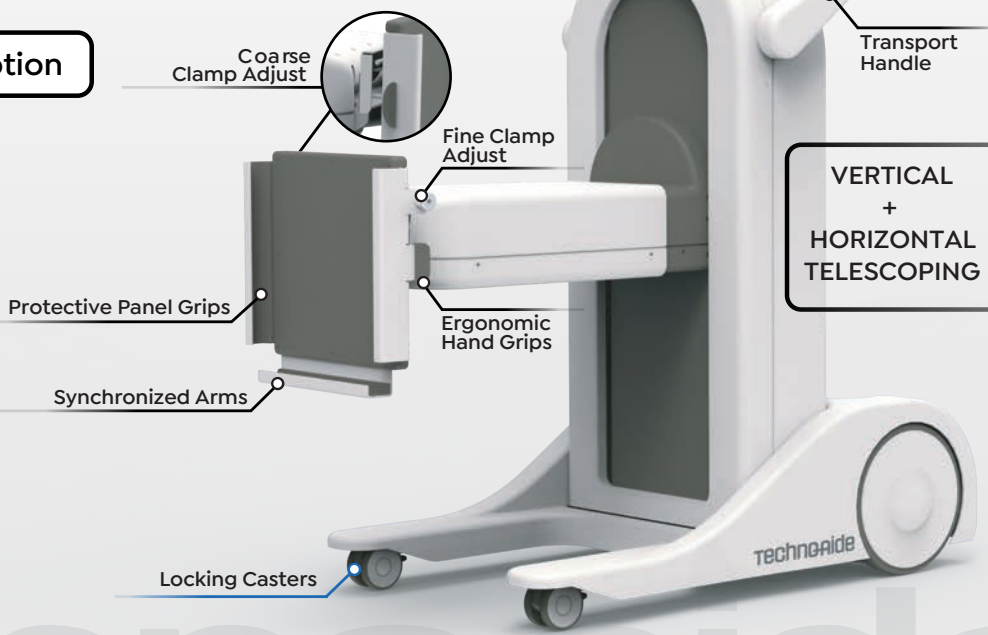
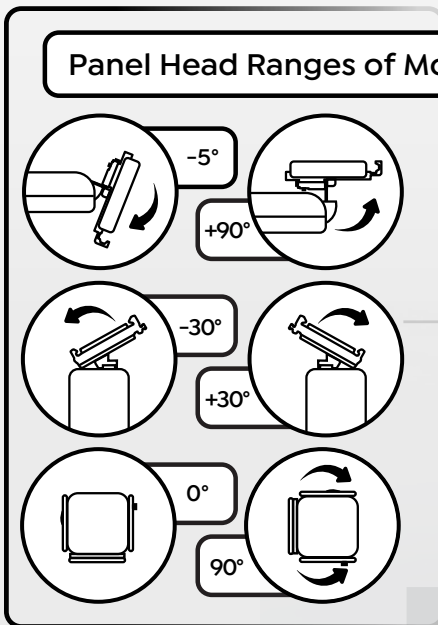
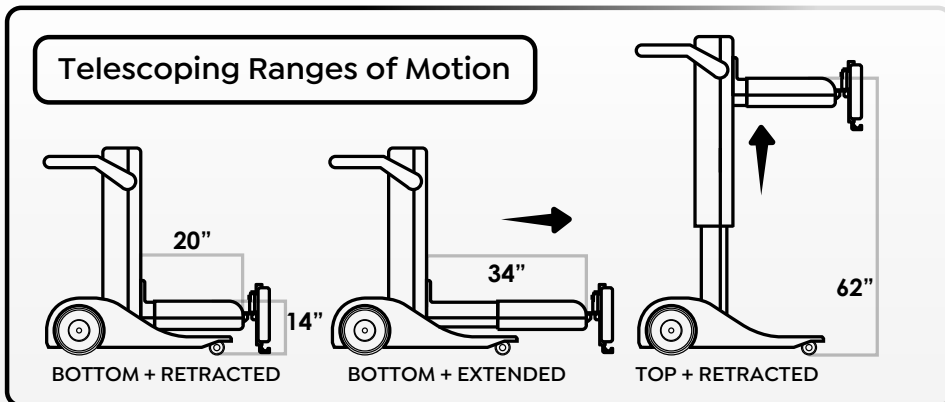
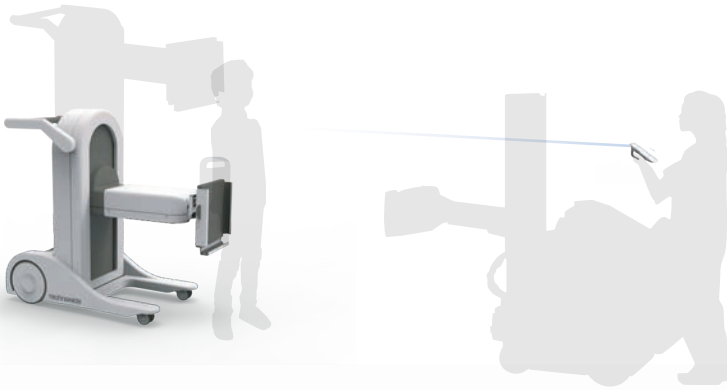

VERTICAL + HORIZONTAL TELESCOPING



A BRIEF GUIDE TO POSITIONING SPONGES

Non-Coated

\$



- Basic (core) piece of porous (open cell) foam, no cover
- No cleanable surface
- Not resistant to fluids
- Not considered durable
- Highly radiolucent
- Artifact free
- Most inexpensive option on average
- Some shapes available in “Stealth” design to reduce the chance of artifacts

Closed Cell

\$\$



- High density, crosslink (closed cell) foam
- **Cleanable surface; No coating/cover required!**
- Entirely resistant to fluids/liquids
- High durability
- Highly radiolucent
- **Artifact free**
- **Most Cost-Effective option**
- “Stealth” design not necessary



Actual Image Under Low Exposure X-Ray



Actual Image Under Low Exposure X-Ray

UNDERSTANDING “STEALTH” SPONGES

NON-STEALTH/“TRADITIONAL” SPONGES

- Typically feature right angles; most common style for positioning sponges
- Right angles show as artifacts during imaging when a form of coating or covering is applied to core sponge

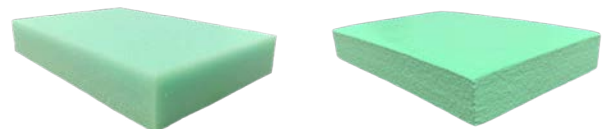



Coated
\$\$\$

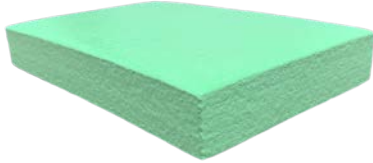

- Open cell foam covered with proprietary medical-grade coating
- Cleanable surface
- Resistant to fluids
- More durable than basic (core) foam
- Semi radiolucent
- Can be artifact free
- Second most expensive option on average
- Some shapes available in “Stealth” design to reduce the chance of artifacts

Vinyl Covered
\$\$\$\$



- Open cell foam covered with completely sewn vinyl cover
- Cleanable surface
- Resistant to fluids
- Extreme durability and comfort
- Semi radiolucent
- Not artifact free (sewn seams will show during most imaging)
- Most expensive option on average
- Not available in “Stealth” design



Actual Image Under Low Exposure X-Ray



Actual Image Under Low Exposure X-Ray

STEALTH/“FLARED” SPONGES

- Flared sides help significantly reduce chance of artifacts during imaging
- Increase overall size of sponge, typically at base of product

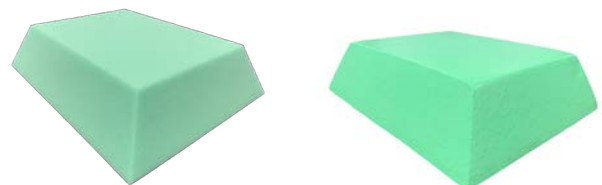



CLOSED CELL WEDGE SPONGES



YX76 - 45° Wedge Sponge
[30" x 9" x 9"]



YXAJ - Knee Wedge Sponge
[22" x 13.5" x 7"]



YXBB - Medium 45° Spinal Body Wedge Sponge [14" x 10" x 5"]



YCBD - 45° Spinal Body Wedge Sponge [27.75" x 10" x 7"]



YXBD - Large 45° Spinal Body Wedge Sponge Set [21" x 7" x 7"]



YXBE - 34° Wedge Sponge Set [10" x 10" x 6"]



YXBF - 27° Wedge Sponge [10" x 10" x 6"]



YXBG - 21° Wedge Sponge Set [11" x 8.5" x 3.5"]



YXBI - 15° Wedge Sponge Set [11" x 7" x 3"]



YXBJ - 12° Wedge Sponge Set [9.5" x 7.25" x 2.25"]



YXBU - 30° x 60° x 90° Multiangle Wedge [24" x 10" x 6"]



YXUZ - Ultrasound Wedge Sponge [20" x 20" x 6"]

CLOSED CELL RECTANGLE SPONGES



YXBN - Rectangle Sponge [18" x 14" x 3"]



YXBR - Rectangle Sponge [6" x 4" x 1"]



YXBT - Rectangle Sponge [6" x 4" x 2"]



YXBV - Square Sponge [6" x 6" x 2"]



YXGF - Rectangle Sponge [12" x 10" x 2"]



YXMB - Rectangle Sponge [10" x 8" x 2"]



YXBL - Rectangle Sponge [10" x 7.5" x 3"]

CLOSED CELL EXTREMITY SPONGES



YXCA - Small Extremity Sponge
[13" x 7" x 3.5"]



YXCB - Medium Extremity Sponge
[19.5" x 11.5" x 5"]



YXCC - Large Extremity Sponge
[30.5" x 11" x 7"]

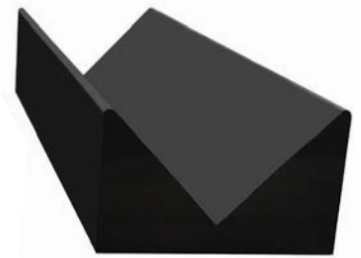

YXCD - XL Extremity Sponge
[44" x 14" x 9"]

CLOSED CELL HAND SPONGES

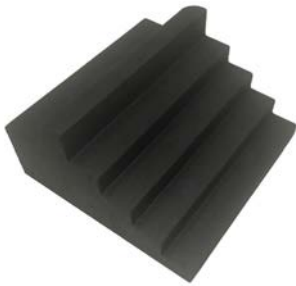

YXAA - Finger Block Sponge
[5" x 5" x 3"]



YXAD - Adult Bi-Lateral Finger Block Set (L & R) [YXFR & YXFL]



YXFL - Left Lateral Finger Block Sponge [6" x 6.125" x 3.25"]



YXFR - Right Lateral Finger Block Sponge [6" x 6.125" x 3.25"]

MISC. CLOSED CELL SPONGES



YXAK - Circular Head Sponge
[Diameter: 7" x 1.5"]



YXAM - Flat Bottom V-Trough/AP & PA Adult Head Holder Sponge [15" x 14" x 4.625"]

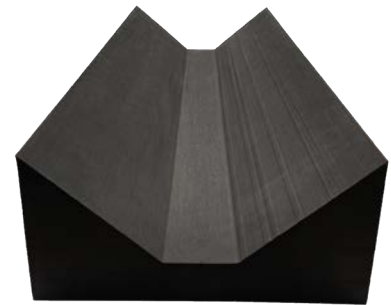

YXCM - Large Flat Bottom V-Trough
[36" x 14" x 4.625"]



YXAY - Specialty Angular Bolster Sponge
[14" x 22.5" x 8"]



YXNZ - Podiatry Axial/Sesamoid Weight Bearing Sponge [13" x 8" x 4"]



YXWB - Weight Bearing Cassette Holder [Overall size: 17.5" x 11.5" x 4" | Channel: 1.1875" x 11.5" x 3"]



CLOSED CELL SPONGE BUNDLES



YB-X-A01 - Veterinary Sponge Bundle
[YXBI, YXBT, YXBR, YXAM, YXBD]



YB-X-A02 - Urgent Care Sponge Bundle [YXAA, YXAD, YXAK, YXBC, YXBD, YXBE, YXBJ, YXBL, YXBN]

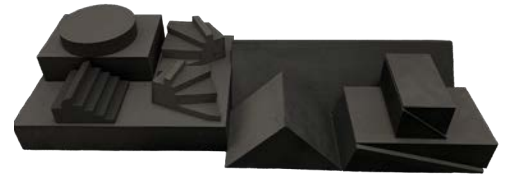

YB-X-A03 - Alternate Urgent Care Sponge Bundle [YXAA, YXAD, YXAK, YXBC, YXBD, YXBE, YXBI, YXBL, YXBN]

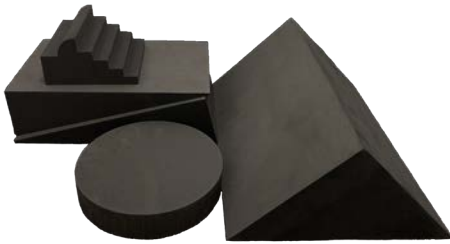

YB-X-A04 - Clinic Sponge Bundle A
[YXAA, YXAK, YXBB, YXBI]



YB-X-A05 - Clinic Sponge Bundle A
[YXAA, YXAK, YXBC, YXBD, YXBE, YXBI, YXBJ, YXBL]



YB-X-A07 - General Sponge Bundle A
[YXAK, YXBC, YXBE, YXBI, YXBL]

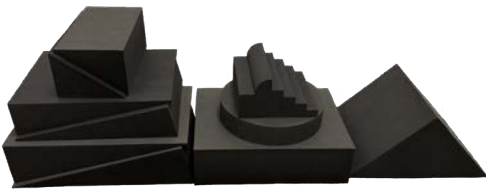

YB-X-A08 - General Sponge Bundle B
[YXAA, YXAK, YXBC, YXBE, YXBI, YXBJ, YXBL]



YB-X-A13 - General Sponge Bundle P
[YXAA, YXAK, YXBD, YXBI]



YB-X-A14 - General Sponge Bundle 1
[YXAA, YXAK, YXBD, YXBI, YXBN, YXBV, YXMB]

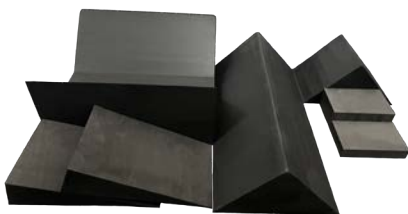

YB-X-A27 - Veterinary Surgery Sponge Bundle
[YXAM, YXBC, YXBD, YXBI, YXBR, YXBT]



YB-X-A28 - General Immobilizer Trough Bundle [YXCA, YXAB, YXCC, YXCD]



YB-X-A29 - Flat Bottom Immobilizer Trough Bundle [YXAM, YXCM]

NON-COATED WEDGE SPONGES (S) - Stealth Sponges



YBBA - (S) 45° Bariatric Spinal Wedge Sponge [27.5" x 10" x 7"]



YFBB - (S) 45° Spinal Wedge Sponge [20.25" x 10" x 7"]



YFBC - (S) 45° Spinal Wedge Sponge [13.5" x 10" x 7"]



YFBD - (S) 45° Spinal Wedge Sponge [27.75" x 10" x 7"]



YFBE - (S) 34° Wedge Sponge Set [9.75" x 5.5" x 3"]

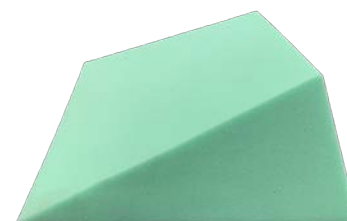

YFBF - (S) 27° Wedge Sponge [15.5" x 12.75" x 6"]

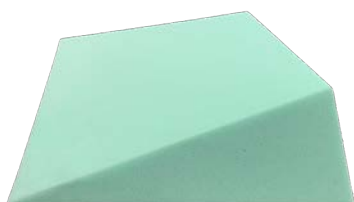

YFBG - (S) 21° Wedge Sponge [14.25" x 12.25" x 4.5"]



YFBH - (S) 16° Wedge Sponge Set [11" x 8.5" x 3.5"]

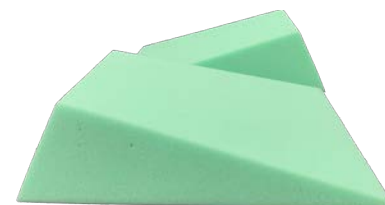

YFBI - (S) 12° Wedge Sponge Set [10" x 12.5" x 3"]



YFBJ - (S) 12° Wedge Sponge Set [14.25" x 12.25" x 4.5"]

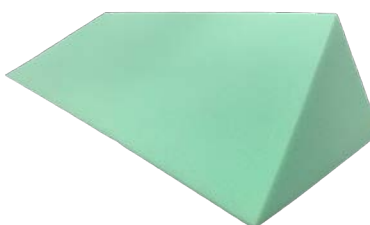

YFBU - (S) 30° x 60° x 90° Multiangle Wedge Sponge [29.5" x 10" x 6"]



YFDB - 30° Cardiac Wedge Sponge [27" x 28" x 16"]



YFEA - (S) 45° Spinal Wedge Sponge [24" x 13.75" x 9.5"]



YFEE - (S) 45° Echocardiography Wedge Sponge [38.25" x 13" x 9"]



YFFD - 45° Spinal Body Wedge Sponge [21" x 7" x 7"]



NON-COATED RECTANGLE SPONGES (S) - Stealth Sponges



YFBL - (S) Rectangle Sponge
[12.5" x 10.25" x 3"]



YFBN - (S) Rectangle Sponge
[20.5" x 16.25" x 3"]



YFBO - (S) Square Sponge
[13.5" x 13.5" x 4"]



YFBY - (S) Rectangle Sponge
[27.5" x 21.5" x 4"]



YFBR - Rectangle Sponge
[6" x 4" x 1"]



YFBT - Rectangle Sponge
[6" x 4" x 2"]



YFEM - Rectangle Sponge
[24" x 15" x 2.5"]

NON-COATED HEAD SPONGES (S) - Stealth Sponges



YFAK - (S) Circular Head Block
[Diameter: 7" (top) x 9" (base) x 1.5"]



YFAM - (S) AP/PA Adult Head Holder
Sponge [16" x 14.5" x 6.5"]



YFAN - (S) AP/PA Child Head
Holder Sponge [11" x 9.75" x 5"]



YFAQ - (S) Child Head Immobilizer
Sponge [11.5" x 6.75" x 5.25"]



YFAR - Cervical Head Rest Sponge
[16" x 7.5" x 4.5"]



YFBW - CT Head Rest Sponge
[12.5" x 11" x 10"]

NON-COATED HAND SPONGES (S) - Stealth Sponges

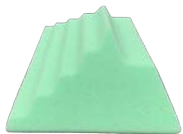

YFAA - (S) Adult Oblique
Finger Block Sponge
[10.5" x 6" x 3"]

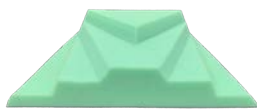

YFAD - (S) Adult Lateral
Finger Block Sponge
[13" x 8" x 3"]



YFAB - (S) Bilateral Adult
Oblique Finger Block
Sponge [20.5" x 16.25" x 3"]



YFAE - (S) Pediatric
Lateral Finger Block
Sponge [7" x 4" x 1.75"]



YFAC - (S) Adult Lateral
Finger Block Sponge
[7.75" x 7.7" x 2"]

NON-COATED SPONGES BUNDLES (S) - Stealth Sponges



YB-F-A02 - Urgent Care Sponge Bundle [YFAA, YFAD, YFAK, YFBC, YFBD, YFBE, YFBJ, YFBL, YFBN]



YB-F-A04 - Clinic Sponge Bundle A [YFAA, YFAK, YFBB, YFBI]



YB-F-A05 - Clinic Sponge Bundle B [YFAA, YFAK, YFBC, YFBD, YFBE, YFBI, YFBJ, YFBL]



YB-F-A06 - CT Positioning Sponge Bundle [YFBB, YFBC, YFBE, YFBF, YFBG, YFBI, YFBJ, YFBW]



YB-F-A07 - General Sponge Bundle A [YFAK, YFBC, YFBE, YFBI, YFBL]



YB-F-A08 - General Sponge Bundle B [YFAA, YFAK, YFBC, YFBE, YFBI, YFBJ, YFBL]



YB-F-A10 - General Sponge Bundle D [YFAL, YFAN, YFAR, YFBF, YFBJ, YFBL]



YB-F-A12 - General Sponge Bundle G [YFAA, YFAK, YFBD, YFBE, YFBI, YFBL]



YB-F-A13 - General Sponge Bundle P [YFAA, YFAK, YFBD, YFBI]



YB-F-A16 - Ortho Sponge Bundle A [YFAA, YFAM, YFAR, YFBD, YFBL]



YB-F-A19 - Pediatric Sponge Bundle [YFAC, YFAE, YFAK, YFAN, YFAQ, YFAX, YFBI]

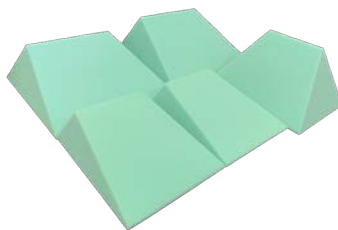

YB-F-A20 - Wedge Sponge Bundle A [YFBC, YFBF, YFBG, YFBI]

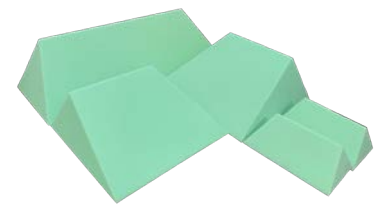

YB-F-A21 - Wedge Sponge Bundle B [YFBD, YFBE, YFBF, YFBG]



COATED WEDGE SPONGES (S) - Stealth Sponges

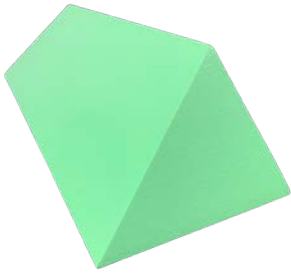

YCBA - (S) 45° Bariatric Spinal Wedge Sponge [27.5" x 10" x 7"]



YCBB - (S) 45° Spinal Wedge Sponge [20.25" x 10" x 7"]

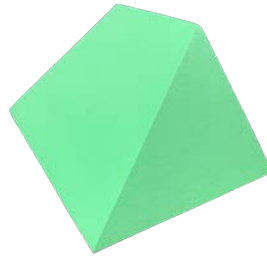

YCBC - (S) 45° Spinal Body Wedge Sponge [13.5" x 10" x 7"]



YCBD - (S) 45° Spinal Body Wedge Sponge [27.75" x 10" x 7"]



YCBE - (S) 34° Wedge Sponge Set [9.75" x 5.5" x 3"]

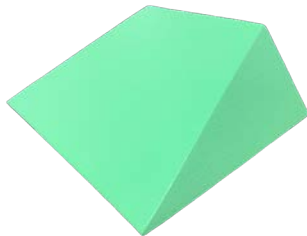

YCBF - (S) 27° Wedge Sponge [15.5" x 12.75" x 6"]

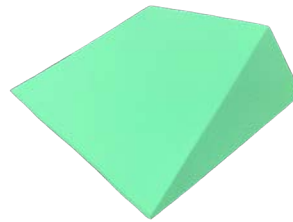

YCBG - (S) 21° Wedge Sponge [14.25" x 12.25" x 4.5"]

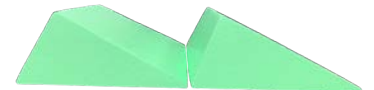

YCBH - (S) 16° Wedge Sponge Set [11" x 8.5" x 3.5"]

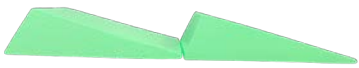

YCBI - (S) 15° Wedge Sponge Set [10" x 12.5" x 3"]

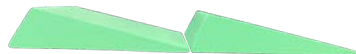

YCBJ - (S) 12° Wedge Sponge Set [9.75" x 10.5" x 2.25"]

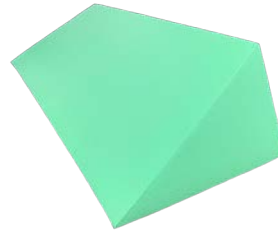

YCBU - (S) 30° x 60° x 90° Multiangle Wedge [29.5" x 10" x 6"]



YCCG - (S) 45° Bariatric Body Wedge Sponge [30" x 9" x 9"]



YCDA - (S) 45° Cardiac Wedge Sponge [28" x 19" x 14"]

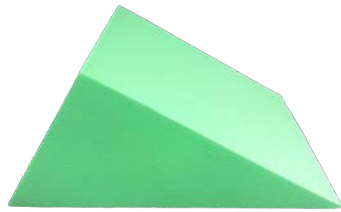

YCDB - (S) 30° Cardiac Wedge Sponge [27" x 28" x 16"]

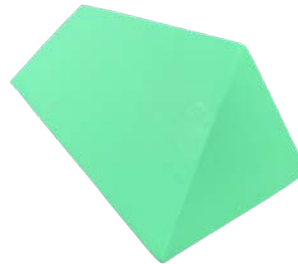

YCEA - (S) 45° Spinal Wedge Sponge [33" x 13.75" x 9.5"]

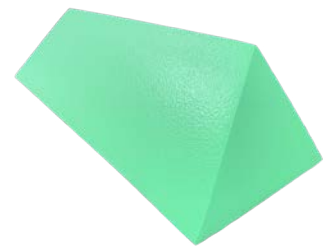

YCEB - (S) 45° Wedge Sponge [30" x 10" x 7.5"]

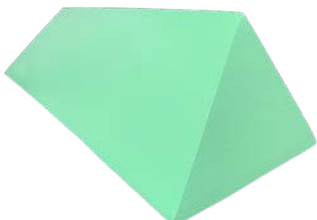

YCEE - (S) 45° XL Echocardiography Wedge Sponge [38.25" x 13" x 9"]

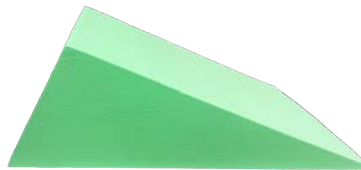

YCEG - (S) 60° Wedge Sponge [25" x 16" x 8.25"]

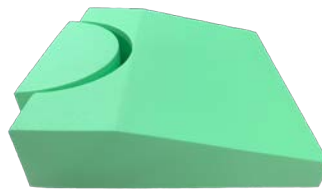

YCEP - Bariatric Endo-Ultrasound Wedge Sponge [16" x 16" x 4.5"]



YCFD - 45° Spinal Wedge Sponge [21" x 7" x 7"]

COATED RECTANGLE SPONGES (S) - Stealth Sponges

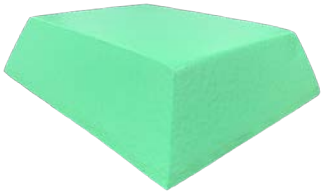

YCBL - (S) Rectangle Sponge
[12.5" x 10.25" x 3"]

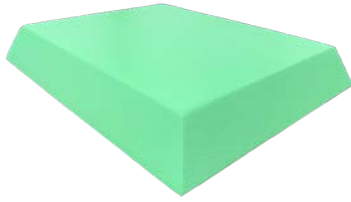

YCBN - (S) Rectangle Sponge
[20.5" x 16.25" x 3"]

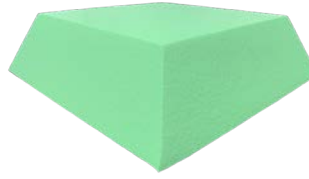

YCBO - (S) Square Sponge
[13.5" x 13.5" x 4"]

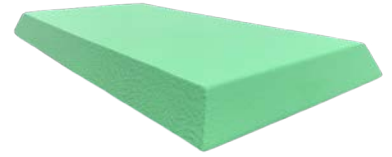

YCGG - (S) Rectangle Sponge
[19.25" x 9.25" x 1.5"]

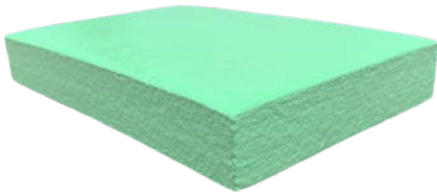

YCBR - Rectangle Sponge
[6" x 4" x 1"]

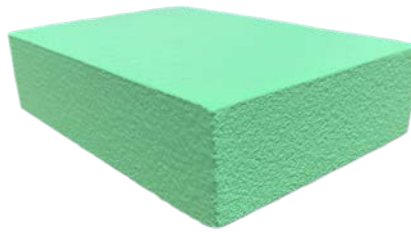

YCBS - Rectangle Sponge
[6" x 4" x 1.5"]

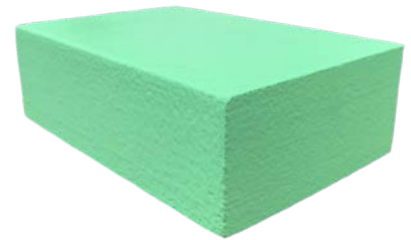

YCBT - Rectangle Sponge
[6" x 4" x 2"]

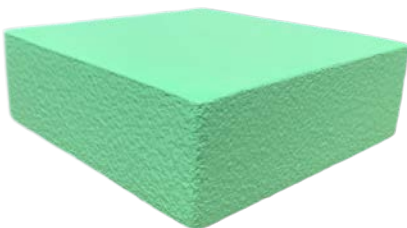

YCBV - Square Sponge
[6" x 6" x 2"]

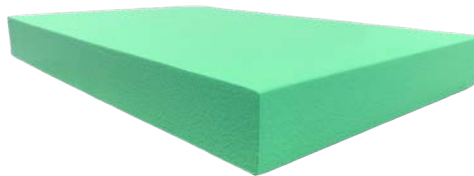

YCEM - Rectangle Sponge
[24" x 15" x 2.5"]

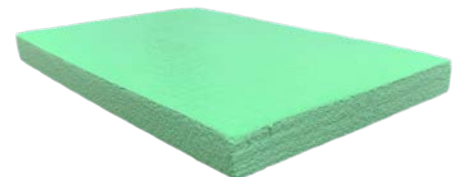

YCBQ - Rectangle Sponge
[6" x 4" x 0.5"]



COATED HEAD SPONGES (S) - Stealth Sponges



YCAK - (S) Circular Head Block
[Diameter: 7" (top) x 9" (base) x 1.5"]

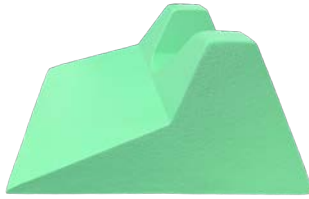

YCAL - (S) Head & Neck Support Sponge
[14" x 16" x 6.5"]

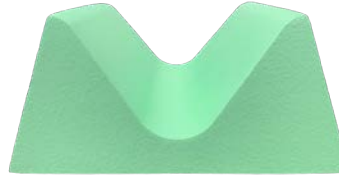

YCAM - (S) AP/PA Adult Head Holder Sponge
[15" x 14" x 6.75"]



YCAM - (S) AP/PA Child Head Holder Sponge
[11" x 9.75" x 5"]



YCAP - (S) Adult Head Immobilizer Sponge
[15.25" x 9" x 7"]

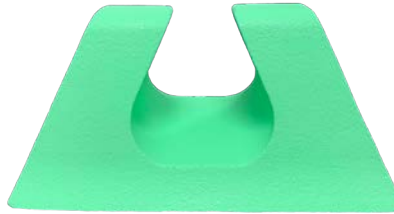

YCAQ - (S) Child Head Immobilizer Sponge
[11.5" x 6.75" x 5.25"]



YCAR - (S) Cervical Head Rest Sponge
[16" x 7.5" x 4.5"]

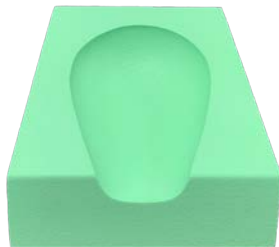

YCBW - CT Headrest Sponge
[12.5" x 11" x 10"]



Y CET - Occipital Head Support Sponge
[13" x 12.75" x 4.5"]

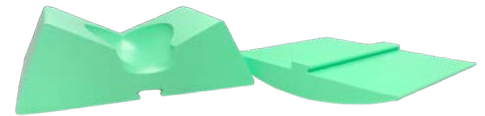

YCEV - CT/PET Head Holder Sponge Set
[13.5" x 14" x 6.75"]

COATED HAND SPONGES (S) - Stealth Sponges

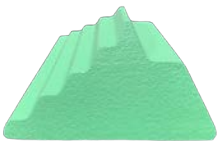

YCAA - (S) Adult Oblique Finger Block Sponge
[10.5" x 6" x 3"]

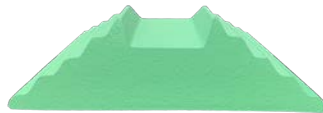

Y CAB - (S) Bilateral Adult Oblique Finger Block Sponge
[12.5" x 10.5" x 3"]

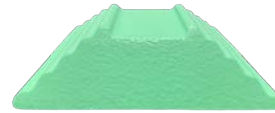

YCAC - (S) Bilateral Pediatric Oblique Finger Block Sponge
[7.75" x 7.7" x 2"]

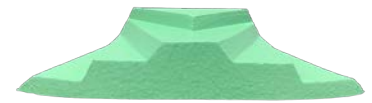

YCAD - (S) Adult Lateral Finger Block Sponge
[13" x 8" x 3"]

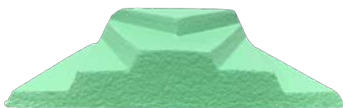

YCAE - (S) Pediatric Lateral Finger Block Sponge
[7" x 4" x 1.75"]

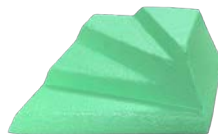

Y CFL - (S) Left Lateral Finger Sponge
[5-6.5" x 7.5" x 3"]

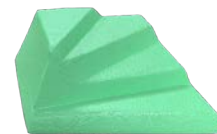

Y CFR - (S) Right Lateral Finger Sponge
[5-6.5" x 7.5" x 3"]

COATED LEG SPONGES (S) - Stealth Sponges



YCAG - (S) Bilateral Leg Immobilizer
Sponge [21" x 20" x 6"]



YCAH - (S) Knee Arthrogram
Block Sponge [19" x 14.5" x 8"]



YCAJ - (S) 26" Knee Wedge
Support Sponge [21" x 19" x 8"]

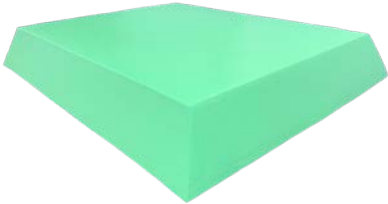

YCBY - (S) Knee Arthrogram
Block Sponge [19" x 14.5" x 8"]



YMCM - (S) Medium Leg Rest w/
Knee Cutouts [16.25" x 12.5" x 7"]

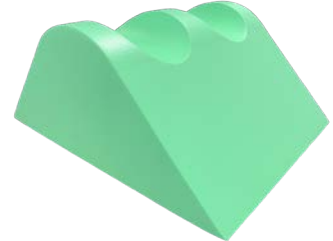

YMCP - (S) Large Leg Rest w/
Knee Cutouts [24" x 18" x 10"]

COATED EXTREMITY SPONGES (S) - Stealth Sponges

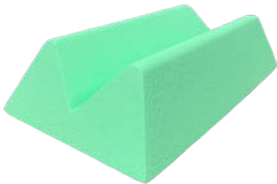

YCCA - (S) Small Extremity
Sponge [12.5" x 7" x 3"]

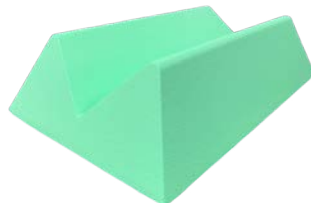

YCCB - (S) Medium Extremity
Sponge [19.75" x 11.5" x 5"]

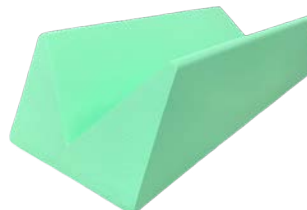

YCCC - (S) Large Extremity
Sponge [30.5" x 11" x 7"]

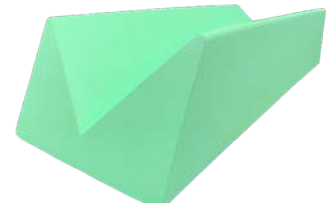

YCCD - (S) X-Large Extremity
Sponge [44.5" x 14" x 9"]

MISC. COATED SPONGES (S) - Stealth Sponges

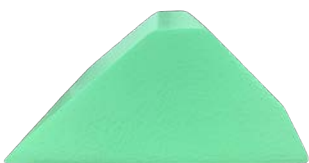

YCAT - (S) Bariatric Torso
Sponge [16.5" x 18.5" x 7"]

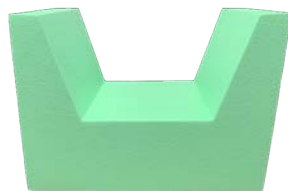

YCAW - Adult Myelogram Block
Sponge [22" x 10" x 14"]

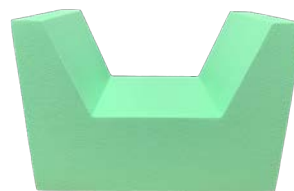

YCAX - Child Myelogram Block
Sponge [14" x 8" x 10"]

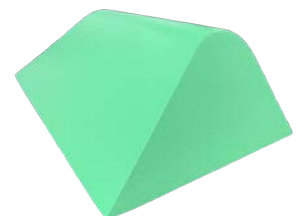

YCAY - (S) Specialty Angular Bolster
Sponge [22.5" x 14" x 7.25"]



COATED SPONGES BUNDLES



YB-C-A02 - Urgent Care Sponge Bundle
[YCAA, YCAD, YCAK, YCBC, YCBD, YCBE, YCBI, YCBL, YCBN]



YB-C-A04 - Clinic Sponge Bundle A
[YCAA, YCAK, YCBB, YCBI]



YB-C-A05 - Clinic Sponge Bundle B
[YCAA, YCAK, YCBC, YCBD, YCBE, YCBI, YCBL, YCBL]



YB-C-A06 - CT Sponge Bundle A
[YCBB, YCBC, YCBE, YCBF, YCBG, YCBI, YCBJ, YCBW]



YB-C-A07 - General Sponge Bundle A
[YCAK, YCBC, YCBE, YCBI, YCBL]



YB-C-A08 - General Sponge Bundle B
[YCAA, YCAK, YCBC, YCBE, YCBI, YCBL, YCBL]



YB-C-A09 - General Sponge Bundle C
[YCAA, YCAH, YCAM, YCAR, YCAY, YCBL]



YB-C-A10 - General Sponge Bundle D
[YCAL, YCAN, YCAR, YCBF, YCBJ, YCBL]



YB-C-A11 - General Sponge Bundle E
[YCAA, YCAK, YCAM, YCAR, YCBB, YCBD, YCBG, YCBI, YCBL, YCBN, YCBU]



YB-C-A12 - General Sponge Bundle G
[YCAA, YCAK, YCBD, YCBE, YCBI, YCBL]



YB-C-A13 - General Sponge Bundle P
[YCAA, YCAK, YCBD, YCBI]

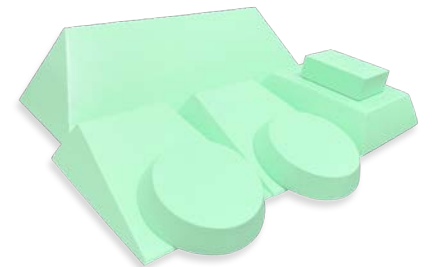

YB-C-A15 - General Sponge Bundle I
[2x - YCAK; 1x - YCBD, YCBI, YCBL, YCBT]



YB-C-A16 - Ortho Sponge Bundle A
[YCAA, YCAM, YCAR, YCBD, YCBL]



YB-C-A17 - Ortho Sponge Bundle B
[YCAL, YCAN, YCAR, YCBC, YCBG, YCBJ, YCBL]



YB-C-A18 - Ortho Sponge Bundle D
[YCAA, YCAR, YCBD, YCBI, YCBL]



YB-C-A19 - Pediatric Sponge Bundle
[YCAC, YCAE, YCAK, YCAN, YCAQ, YCAX]



YB-C-A20 - Wedge Sponge Bundle A
[YCBC, YCBF, YCBG, YCBI]



YB-C-A21 - Wedge Sponge Bundle B
[YCBD, YCBE, YCBF, YCBG]



YB-C-A22 - Bariatric Sponge Bundle
[YCAT, YCBA, YCBM, YCBP]

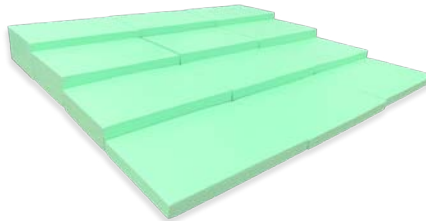

YB-C-A23 - Rectangle Sponge Bundle
[3 ea. - YCBQ, YCBR, YCBS, YCBT]

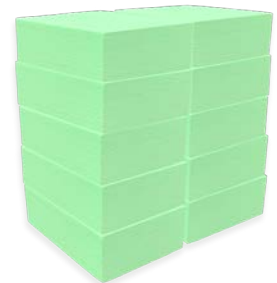

YB-C-A24 - Scanning Support Sponge Bundle [10 ea. - YCBT]



YB-C-A25 - Ultrasound Sponge Bundle
[YCAV, YCEE, YCUZ]



YB-C-A26 - Ultrasound Breast or Paracentesis
Sponge Bundle [YCBG, YCFD, YCBU]



VINYL WEDGE SPONGES



YVBI - 15° Wedge Sponge Set
[10" x 7" x 2"]

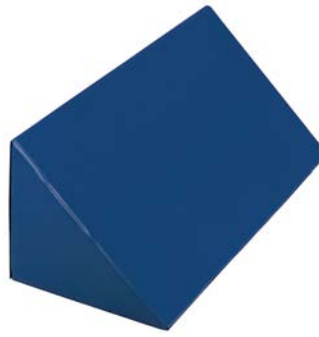

YVDA - 45° Cardiac Wedge Sponge
[28" x 14" x 14"]



YVFA0 - Knee Wedge Bolster Sponge
[17" x 13" x 6"]



YVFC - 20° Wedge Bolster Sponge
[24" x 18" x 6"]



YVFD - 45° Wedge Bolster Sponge
[16" x 8" x 8"]



YVFF - 50° Incline Wedge Bolster Sponge
[32" x 20" x 12"]



YVFM - Knee Wedge Bolster Sponge
[25" x 16" x 8.25"]



YVFO - 45° Spinal Wedge Bolster Sponge
[21" x 7" x 7"]



YVFU - 30° x 60° x 90° Wedge Sponge
[24" x 10" x 6"]



YVfZ - Endo-Ultrasound Wedge Sponge
[20" x 20" x 6"]



YVWA - Specialty Stretcher & Wheelchair
Wedge Sponge [24.5" x 14" x 5.5-14"]

VINYL WEDGE SPONGES



YVFG - Rectangle Bolster Sponge
[12" x 8" x 6"]

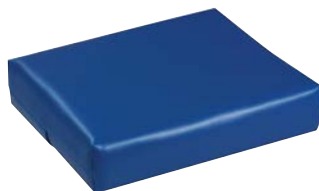

YVFH - Rectangle Bolster Sponge
[14" x 12" x 3"]



YVFI - Rectangle Bolster Sponge
[12" x 8" x 3"]

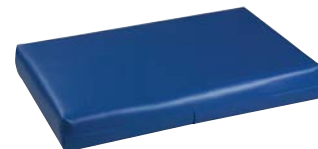

YVFK - Rectangle Bolster Sponge
[20" x 13" x 3"]



YVFP - Rectangle Bolster Sponge
[24" x 18" x 4"]



YVBR - Rectangle Sponge
[6" x 4" x 1"]



YVBT - Rectangle Sponge
[6" x 4" x 2"]

MISC. VINYL SPONGES



YVAM - Flat Bottom V-Trough/AP
& PA Adult Head Holder Sponge
[15" x 14" x 6.75"]



YVFA - Cylinder Bolster
Sponge [24" x 8" x 8"]



YVFB - Semi-Cylinder
Bolster Sponge [18" x 8" x 6"]



YVFQ - DEXA Leg Bolster
Sponge [20" x 20" x 12"]

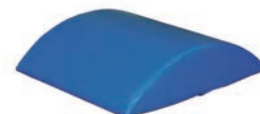

YVWS - Specialty Wheelchair
Bolster Sponge [17" x 13" x 6"]

VINYL SPONGE BUNDLE



YB-V-A01 - Vinyl Covered
Sponge
Bundle [YVBI, YVBT, YVBR, YVAM, YVFO]



**HEAVY-GAUGE VINYL SQUARE
SANDBAGS:
STANDARD HANDLES**



FLEXIBLE VINYL SANDSOCKS



**HEAVY-GAUGE VINYL RECTANGULAR
SANDBAGS: STANDARD HANDLES**



**HEAVY-GAUGE VINYL SQUARE
SANDBAGS:
AC JOINT HANDLES**



SANDSOCK BUNDLES



**HEAVY-GAUGE VINYL RECTANGULAR
SANDBAGS: AC JOINT HANDLES**



GP0132 - Nylon Covered MRI Rectangle
Positioner Set (Set of 2) [14" x 3" x 1"]



SPG1003-01 - MRI Heavy-Gauge Vinyl Square
Sandbag: 3lb (8 x 8) - Standard Handle [Black]



SPG1013-01 - MRI Heavy-Gauge Vinyl
Sandbag Bundle - Standard Handle [Black]

MRI SAFE POSITIONERS

SKU	Part Description
GP0132	MRI Rectangle Positioner Set (2) [14" x 3" x 1"]
GP0152	MRI Rectangle Positioner Set (2) [5" x 3" x 1"]
GP0162	MRI Wedge Positioner Set (2) [10" x 10" x 3"]
GP0172	MRI Wedge Positioner Set (2) [14" x 4" x 1.5"]
GP0182	MRI Rectangle Positioner Set (2) [4" x 3" x 2"]
GP0192	MRI Curved Wedge Positioner Set (2) [14" x 4" x 1.5"]
GP0202	MRI Semi-Round Neck Roll Positioner [7" x 3" x 2.3"]
GE1211	MRI Knee Wedge Positioner [28.2" x 16" x 8"]
GP0102	MRI Positioner Bundle [1 ea. - MFP-01 - 06]

MRI SAFE SANDBAGS

SKU	Part Description
SBG1003-01	Square Sandbag: 3lb (8 x 8) Standard Handle [Black]
SBG1005-01	Rectangle Sandbag: 5lb (5 x 15) Standard Handle [Black]
SBG1007-01	Rectangle Sandbag: 7lb (9 x 12) Standard Handle [Black]
SBG1010-01	Rectangle Sandbag: 10lb (9 x 14) Standard Handle [Black]
SBG1012-01	Square Sandbag: 12lb (12 x 12) Standard Handle [Black]
SBG1013-01	Sandbag Bundle: One of each size [Black]



SANDSOCKS

1lb (2 x 8)	Standard	3lb (4 x 12)	Standard
Black	SS-01R-BLK-NH	Black	SS-03R-BLK-NH
Tan	SS-01R-TAN-NH	Tan	SS-03R-TAN-NH
4lb (8 x 10)	Standard	5lb (6 x 15)	Standard
Black	SS-04R-BLK-NH	Black	SS-05R-BLK-NH
Tan	SS-04R-TAN-NH	Tan	SS-05R-TAN-NH
7lb (6 x 18)	Standard	8lb (7 x 22)	Standard
Black	SS-07R-BLK-NH	Black	SS-08R-BLK-NH
Tan	SS-07R-TAN-NH	Tan	SS-08R-TAN-NH
10lb (6 x 20)	Standard	11lb (6 x 28)	Standard
Black	SS-10R-BLK-NH	Black	SS-11R-BLK-NH
Tan	SS-10R-TAN-NH	Tan	SS-11R-TAN-NH
12lb (6 x 25)	Standard	15lb (6 x 40)	Standard
Black	SS-12R-BLK-NH	Black	SS-15R-BLK-NH
Tan	SS-12R-TAN-NH	Tan	SS-15R-TAN-NH

SANDSOCK BUNDLES

Bundle 1	Standard	Bundle 2	Standard
Black	SSK-01-BLK-NH	Black	SSK-02-BLK-NH
Tan	SSK-01-TAN-NH	Tan	SSK-02-TAN-NH
Bundle 3	Standard	Bundle 4	Standard
Black	SSK-03-BLK-NH	Black	SSK-04-BLK-NH
Tan	SSK-03-TAN-NH	Tan	SSK-04-TAN-NH

RECTANGLE SANDBAGS

1lb (4 x 5)	Standard	ACJoint	2lb (4 x 9)	Standard	ACJoint
Black	SB-01R-BLK-ST	SB-01R-BLK-AC	Black	SB-02R-BLK-ST	SB-02R-BLK-AC
Blue	SB-01R-BLU-ST	SB-01R-BLU-AC	Blue	SB-02R-BLU-ST	SB-02R-BLU-AC
3lb (5 x 9)	Standard	ACJoint	5lb (6 x 12)	Standard	ACJoint
Black	SB-03R-BLK-ST	SB-03R-BLK-AC	Black	SB-05R-BLK-ST	SB-05R-BLK-AC
Blue	SB-03R-BLU-ST	SB-03R-BLU-AC	Blue	SB-05R-BLU-ST	SB-05R-BLU-AC
7lb (6 x 14)	Standard	ACJoint	10lb (7 x 16)	Standard	ACJoint
Black	SB-07R-BLK-ST	SB-07R-BLK-AC	Black	SB-10R-BLK-ST	SB-10R-BLK-AC
Blue	SB-07R-BLU-ST	SB-07R-BLU-AC	Blue	SB-10R-BLU-ST	SB-10R-BLU-AC
12lb (8 x 18)	Standard	ACJoint			
Black	SB-12R-BLK-ST	SB-12R-BLK-AC			
Blue	SB-12R-BLU-ST	SB-12R-BLU-AC			

SQUARE SANDBAGS

5lb (9 x 9)	Standard	ACJoint
Black	SB-05S-BLK-ST	SB-05S-BLK-AC
Blue	SB-05S-BLU-ST	SB-05S-BLU-AC
7lb (10 x 10)	Standard	ACJoint
Black	SB-07S-BLK-ST	SB-07S-BLK-AC
Blue	SB-07S-BLU-ST	SB-07S-BLU-AC
10lb (11 x 11)	Standard	ACJoint
Black	SB-10S-BLK-ST	SB-10S-BLK-AC
Blue	SB-10S-BLU-ST	SB-10S-BLU-AC

SANDBAG BUNDLES

Bundle 1	Standard	Bundle 2	Standard
Black	SBK-01-BLK-ST	Black	SBK-02-BLK-ST
Blue	SBK-01-BLU-ST	Blue	SBK-02-BLU-ST
Pediatric	Standard	Femoral/Angio	Standard
Black	SBK-03-BLK-ST	Black	SBK-04-BLK-ST
Blue	SBK-03-BLU-ST	Blue	SBK-04-BLU-ST

SANDBAG PAIRS

5lb Pair (9 x 9)	Standard	ACJoint
Black	SBPR-05S-BLK-ST	SBPR-05S-BLK-AC
Blue	SBPR-05S-BLU-ST	SBPR-05S-BLU-AC
10lb Pair (11 x 11)	Standard	ACJoint
Black	SBPR-10S-BLK-ST	SBPR-10S-BLK-AC
Blue	SBPR-10S-BLU-ST	SBPR-10S-BLU-AC



Platform Stools & Specialty Positioning Aids



WMP-2S - Two Step Weight Bearing Imaging Platform (Comfort Closed Cell Steps)



WMP-3H - Three Step Weight Bearing Imaging Platform (Reinforced Plastic Steps)



A.2CompleteView4CS - Complete View 2-Step Platform w/ Swivel 360 system (includes 14x17 Lock-N-Secure II)



FIL-12 - Patient Foot Immobilizer



LGS - Adjustable Leg Support - Bariatric Base (15" x 18")



31220 - Dual Platform Bariatric Step Stool with Handrail

SPECIALTY POSITIONING AIDS

SKU	Part Description
FIL-12	Patient Foot Immobilizer
LGS	Adjustable Leg Support - Bariatric Base [15" x 18"]
LGS-S	Adjustable Leg Support - Standard Base [9" x 12"]
RHI-AB	Patient Head Immobilizer [Coated Sponge - 6 x 6 x 2]
RIS-60-BLK	Heavy-Gauge Vinyl Patient Immobilizer Strap [60" x 10"]
RIS-72-BLK	Heavy-Gauge Vinyl Patient Immobilizer Strap [72" x 10"]
RIS-84-BLK	Heavy-Gauge Vinyl Patient Immobilizer Strap [84" x 10"]
RIS-96-BLK	Heavy-Gauge Vinyl Patient Immobilizer Strap [96" x 10"]
RLC-36	Lateral Chest Image Support Positioner [36"]
RLC-48	Lateral Chest Image Support Positioner [48"]

STANDARD & MRI PLATFORM TOOLS

SKU	Part Description
T-50	Standard Single Platform Step Stool with Handrail
T-6150	Single Platform Bariatric Step Stool with Handrail
31220	Dual Platform Bariatric Step Stool with Handrail
FSA3001-01	MRI Single Platform Step Stool with Handrail
FSM1726-01	MRI Dual Platform Step Stool with Handrail
WMP-2S	Two Step Weight Bearing Imaging Platform (Closed Cell)
WMP-2H	Two Step Weight Bearing Imaging Platform (Plastic)
WMP-3S	Three Step Weight Bearing Imaging Platform (Closed Cell)
WMP-3H	Three Step Weight Bearing Imaging Platform (Plastic)



VIT-B - Vinyl Veterinary Immobilizer Trough Bundle
[one of each size: Small-XL]



YXCA - S Closed Cell Veterinary Immobilizer Trough
[10" x 4" x 3"]



NON-COATED THIN RECTANGULAR PAD
YS-F-A01



SANDSOCK BUNDLES
SSK-02-TAN-NH

VETERINARY POSITIONING AIDS

SKU	Part Description
YXCA	S Closed Cell Veterinary Immobilizer Trough [10" x 4" x 3"]
YXCB	M Closed Cell Veterinary Immobilizer Trough [15" x 7" x 5"]
YXCC	L Closed Cell Veterinary Immobilizer Trough [24" x 11" x 7"]
YXCD	XL Closed Cell Veterinary Immobilizer Trough [36" x 14" x 9"]
YB-X-A28	Closed Cell Immobilizer Trough Bundle (1 Each - YXCA, YXCB, YXCC, YXCD)
Q15645	Thin Elastic Extremity Straps - .625 (5/8)" x 29" [Set of 2]
Q15647	Standard Elastic Extremity Straps - 1" x 29" [Set of 2]
Q15648	Extremity Straps Table Liner - 15' (5 yds) [Black]
Q15645-B	Thin Extremity Straps Bundle: 0.625 (5/8)" x 29" [Set of 2] + Q15648
Q15647-B	Standard Extremity Strap Bundle: 1" x 29" [Set of 2] + Q15648
VIS-60-BLK	Vinyl Veterinary Immobilizer Strap [60" x 5"]

SKU	Part Description
VIS-72-BLK	Vinyl Veterinary Immobilizer Strap [72" x 5"]
VIS-84-BLK	Vinyl Veterinary Immobilizer Strap [84" x 5"]
VIS-96-BLK	Vinyl Veterinary Immobilizer Strap [96" x 5"]
VIT-S	S Vinyl Veterinary Immobilizer Trough [10" x 4" x 3"]
VIT-M	M Vinyl Veterinary Immobilizer Trough [15" x 7" x 5"]
VIT-L	L Vinyl Veterinary Immobilizer Trough [24" x 11" x 7"]
VIT-X	XL Vinyl Veterinary Immobilizer Trough [36" x 14" x 9"]
VIT-B	Vinyl Veterinary Immobilizer Trough Bundle [one of each size: Small-XL]
SSK-02-TAN-NH	Flexible Vinyl Sandsock General Bundle 2 (Tan) [SS-01 (2X), SS-03 (2X), SS-05 (4X), SS-11 (2X), 22-12 (4X), SS-15 (2X)]
YS-F-A01	Non-Coated Thin Rectangular Pad (Set of 2 - 24" x 18" x 0.25")
PAD-VS1	Standard Veterinary Radiolucent X-Ray Table Pad: 58" x 30" x 1" - Black Vinyl [No Grommets]



ECONOMY TABLE PADS

- Economic option for patient comfort and stability
- Ideal for x-ray tables or stretchers
- Available in universal lengths and widths to fit most standard imaging tables
- Tapered ends with optional brass grommets to hang pad when not in use
- Made from radiolucent foam and vinyl material
- Easy to clean and sanitize!
- Available in two premium foam types



STANDARD TABLE PADS

- Upgraded vinyl provides a more durable pad
- Perfect for x-ray tables and stretchers
- Increases patient comfort and stability
- Available in universal lengths and widths to fit most standard imaging tables
- Tapered ends with optional brass grommets to hang pad when not in use
- Made from radiolucent foam and vinyl material
- Easy to clean and sanitize!
- Available in two premium foam types
- Choose from Black or Blue comfort vinyl, or our impact resistant Techno-Tuff™ Black vinyl



PREMIUM TABLE PADS

- Features premium sewn and sealed boxed corners for a superior finished look
- Perfect for x-ray tables and stretchers
- Increases patient comfort and stability
- Available in universal lengths and widths to fit most standard imaging tables
- Made from radiolucent foam and material
- Easy to clean and sanitize!
- Available in three premium foam types
- Choose from Black or Blue comfort vinyl, or ultra-comfort memory foam with a premium 4-way stretch black fabric



WALL MOUNTED TABLE PAD RACK

Designed to work specifically with Techno-Aide grommeted table pads, this durable low-profile wall-mounted rack lets you quickly hang your table pad when not in use.



PAD-R2

VETERINARY TABLE PADS

STANDARD (L x W) - 58" x 30" / LARGE (L x W) - 65" x 30"

1" Thick Comfort Foam	Standard	Large
Economy Vinyl	PAD-VSI-BLK-NG	PAD-VLI-BLK-NG

ECONOMY TABLE PADS

STANDARD (L x W) - 72" x 23.25"

1" Thick Comfort Foam	No Grommets	With Grommets
Economy Vinyl	PAD-ST1-ECO-NG	PAD-ST1-ECO-WG
2" Thick Firm Foam	No Grommets	With Grommets
Economy Vinyl	PAD-ST2-ECO-NG	PAD-ST2-ECO-WG

STANDARD PLUS (L x W) - 80" x 30"

1" Thick Comfort Foam	No Grommets	With Grommets
Economy Vinyl	PAD-SPI-ECO-NG	PAD-SPI-ECO-WG
2" Thick Firm Foam	No Grommets	With Grommets
Economy Vinyl	PAD-SP2-ECO-NG	PAD-SP2-ECO-WG

STANDARD TABLE PADS

STANDARD (L x W) - 72" x 23.25"

1" Thick Comfort Foam	No Grommets	With Grommets
Black Vinyl	PAD-ST1-BLK-NG	PAD-ST1-BLK-WG
Blue Vinyl	PAD-ST1-BLU-NG	PAD-ST1-BLU-WG
Techno-Tuff Black Vinyl	PAD-ST1-TBK-NG	PAD-ST1-TBK-WG
2" Thick Firm Foam	No Grommets	With Grommets
Black Vinyl	PAD-ST2-BLK-NG	PAD-ST2-BLK-WG
Blue Vinyl	PAD-ST2-BLU-NG	PAD-ST2-BLU-WG
Techno-Tuff Black Vinyl	PAD-ST2-TBK-NG	PAD-ST2-TBK-WG

STANDARD PLUS (L x W) - 80" x 30"

1" Thick Comfort Foam	No Grommets	With Grommets
Black Vinyl	PAD-SPI-BLK-NG	PAD-SPI-BLK-WG
Blue Vinyl	PAD-SPI-BLU-NG	PAD-SPI-BLU-WG
Techno-Tuff Black Vinyl	PAD-SPI-TBK-NG	PAD-SPI-TBK-WG
2" Thick Firm Foam	No Grommets	With Grommets
Black Vinyl	PAD-SP2-BLK-NG	PAD-SP2-BLK-WG
Blue Vinyl	PAD-SP2-BLU-NG	PAD-SP2-BLU-WG
Techno-Tuff Black Vinyl	PAD-SP2-TBK-NG	PAD-SP2-TBK-WG

PREMIUM TABLE PADS

STANDARD (L x W) - 72" x 23.25"

2" Thick Comfort Foam	Standard Backing	Anti-Slip Backing
Black Vinyl	CPAD-PRC-BLK-ST	CPAD-PRC-BLK-AS
Blue Vinyl	CPAD-PRC-BLU-ST	CPAD-PRC-BLU-AS
4-Way Stretch Black Vinyl	CPAD-PRC-4WY-ST	CPAD-PRC-4WY-AS
2" Thick Firm Foam	Standard Backing	Anti-Slip Backing
Black Vinyl	CPAD-PRF-BLK-ST	CPAD-PRF-BLK-AS
Blue Vinyl	CPAD-PRF-BLU-ST	CPAD-PRF-BLU-AS
4-Way Stretch Black Vinyl	CPAD-PRF-4WY-ST	CPAD-PRF-4WY-AS
2" Thick Memory Foam	Standard Backing	Anti-Slip Backing
4-Way Stretch Black Vinyl	CPAD-PRM-4WY-ST	CPAD-PRM-4WY-AS

STANDARD PLUS (L x W) - 80" x 30"

2" Thick Comfort Foam	Standard Backing	Anti-Slip Backing
Black Vinyl	CPAD-PPC-BLK-ST	CPAD-PPC-BLK-AS
Blue Vinyl	CPAD-PPC-BLU-ST	CPAD-PPC-BLU-AS
4-Way Stretch Black Vinyl	CPAD-PPC-4WY-ST	CPAD-PPC-4WY-AS
2" Thick Firm Foam	Standard Backing	Anti-Slip Backing
Black Vinyl	CPAD-PPF-BLK-ST	CPAD-PPF-BLK-AS
Blue Vinyl	CPAD-PPF-BLU-ST	CPAD-PPF-BLU-AS
4-Way Stretch Black Vinyl	CPAD-PPF-4WY-ST	CPAD-PPF-4WY-AS
2" Thick Memory Foam	Standard Backing	Anti-Slip Backing
4-Way Stretch Black Vinyl	CPAD-PPM-4WY-ST	CPAD-PPM-4WY-AS



2931-PL-10 - "Caution Radiation" X-Ray Room Sign - Yellow Sign/Magenta Letters (10" x 7")



2931-PL-11 - "Caution Radiation Area" X-Ray Room Sign - Yellow Sign/Magenta Letters (10" x 7")



2931-PL-16 - "Caution X-Ray Radiation Area" X-Ray Room Sign - Yellow Sign/Magenta Letters (10" x 7")



2931-PL-12 - Bilingual Pregnancy X-Ray Room Sign - Black Sign/White Letters (10" x 7")



2931-PL-14 - "Caution X-Ray In Use" Room Sign - Black Sign/White Letters (10" x 7")



900X - Standard Illuminated Sign - X-Ray In Use



302-IMC - Adjustable Seated 4-Leg Stool (Spin-Lift)

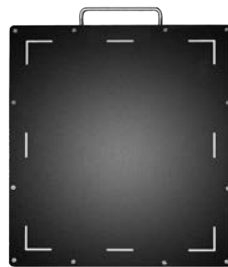

WBC-1417CF - Carbon Fiber Weight Bearing Cassette/Panel/Receptor Protector



LRH - Lateral Imaging Receptor Holder



T-50 - Standard Single Platform Step Stool with Handrail



29602 - Double Film Standard Illuminator View Box - Fluorescent Lamp



31220 - Dual Platform Bariatric Step Stool with Handrail



ALUMINUM VERTICAL MARKERS



TA-EAP001 - Aluminum Right & Left (5/8") Vertical Markers - No Characters [Set]

TA-EAP011 - Aluminum Right & Left (1") Vertical Markers - No Characters [Set]

PLASTIC VERTICAL MARKERS



TA-EPP003 - Plastic Right & Left (5/8") Vertical Markers - 3 Characters Max [Set]

TA-EPP011 - Plastic Right & Left (1") Vertical Markers - No Characters [Set]

VERTICAL POSITION INDICATOR MARKERS



TA-PAP03-V - Aluminum Right & Left (5/8") Vertical Position Indicator Markers - 3 Characters Max [Set]

TA-PPP03-V - Plastic Right & Left (5/8") Vertical Position Indicator Markers - 2 Characters Max [Set]

ALUMINUM HORIZONTAL MARKERS

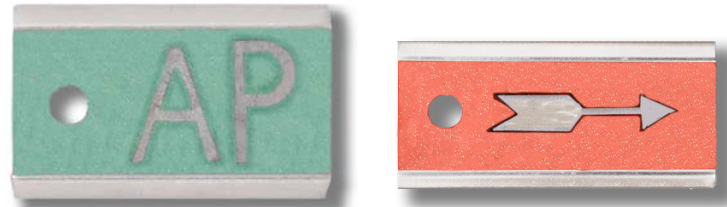

TA-EAW011 - Aluminum Word Horizontal Markers (3/8") - 11 Characters Max [Single]

TA-EA1000 - Aluminum Arrow (1") Multi-Directional Markers - No Characters [Single]

PLASTIC HORIZONTAL MARKERS



TA-EPW010 - Plastic Word Horizontal Markers (3/8") - 11 Characters Max [Single]

TA-EPA1000 - Plastic Arrow (1") Multi-Directional Markers - No Characters [Single]



TA-MRKSTK - Marker Mates - Reusable Marker Adhesives [Set]



MARKER WITH MARKER MATES



TA-HBM016 - Wall Mounted Marker Storage Board [16 Pegs]



ES-25-11 - Flexible Image Scaling Device [Single 25mm Sphere Marker Included]

PART NUMBER
DESCRIPTION

PROTECTIVE APPAREL

100V-DKB	Premium Full Coverage Radiation Safety Finger Gloves (Single Pair)
101SLMIT-DKB	Premium Full Coverage Radiation Safety Mitts With Dexterity Palm Slit (Single pair)
305101	Lite Surgical Radiation Protection Gloves - 0.20mm [Size 6.5 - XS] (Qty. 5 Pairs)
305102	Lite Surgical Radiation Protection Gloves - 0.20mm [Size 7 - S] (Qty. 5 Pairs)
305103	Lite Surgical Radiation Protection Gloves - 0.20mm [Size 7.5 - M] (Qty. 5 Pairs)
305104	Lite Surgical Radiation Protection Gloves - 0.20mm [Size 8 - L] (Qty. 5 Pairs)
305105	Lite Surgical Radiation Protection Gloves - 0.20mm [Size 8.5 - XL] (Qty. 5 Pairs)
305202	Max Surgical Radiation Protection Gloves - 0.40mm [Size 7 - S] (Qty. 5 Pairs)
305203	Max Surgical Radiation Protection Gloves - 0.40mm [Size 7.5 - M] (Qty. 5 Pairs)
305204	Max Surgical Radiation Protection Gloves - 0.40mm [Size 8 - L] (Qty. 5 Pairs)
ACUST	Custom Apparel Adjustment
AGR-105	Wall Mounted Apron Hanging Rack
AGR-110	Wall Mounted Apron Hanging & Glove Rack
AHDT23	Apparel 2023 Date Tags - Pink (Pack of 50)
AHDT24	Apparel 2024 Date Tags - White (Pack of 50)
AHDT25	Apparel 2025 Date Tags - Red (Pack of 50)
AHQRC	Apron-Hub QR Serial Number Labels (Single roll of 100 labels)
AHPAT24	QR Apron Hub Date Tags - White (Pack of 20)
AHPAT25	QR Apron Hub Date Tags - (Pack of 20)
AHPATTOOL	Apron Hub Apron Tag Applicator
APRONBAG	Apron Tote Bag
APRONSIZE TOOL-TA	Techno-Aide's EZ Fit Sizing Tool
AQRT	ApronHub Adhesive QR Tag
ARH-01	Steel Apron Hanger (Single)
ARH-10	Steel Apron Hanger (Qty. of 10 hangers)
ARM-100	Mobile Swing-Arm Apron Rack - 10 Arms (Swing Left & Right) [White]
ARM-G60	Mobile Swing-Arm Apron Rack - 10 Arms with 6 Glove Holders (Swing Left & Right) [White]
ARM-L5	Mobile Swing-Arm Apron Rack - 5-Arms (Swing Left) [White]
ARM-R5	Mobile Swing-Arm Apron Rack - 5-Arms (Swing Right) [White]
ARM-UZ10	Mobile Z-Base Apron Storage Rack with 10 Steel Spron Hangers
ARP-02-61	Wall Mounted Storage Rack - 2 Pegs [White]
ARP-06-61	Wall Mounted Storage Rack - 6 Pegs [White]
ARP-08-61	Wall Mounted Storage Rack - 8 Pegs [White]
ARW-10	Wall Mounted Swing-Arm Apron Rack - 10-Arms (Swing Left & Right) [White]
ARW-L5	Wall Mounted Swing-Arm Apron Rack - 5-Arms (Swing Left) [White]
ARW-R5	Wall Mounted Swing-Arm Apron Rack - 5-Arms (Swing Right) [White]
AS-3R	Blanket Guard - Small (18" x 18")/0.35mm Regular Lead
AS-3L	Blanket Guard - Small (18" x 18")/0.35mm Lightweight Lead
AS-3N	Blanket Guard - Small (18" x 18")/0.35mm Lead-Free Bilayer
AM-3R	Blanket Guard - Medium (24" x 24")/0.35mm Regular Lead
AM-3L	Blanket Guard - Medium (24" x 24")/0.35mm Lightweight Lead
AM-3N	Blanket Guard - Medium (24" x 24")/0.35mm Lead-Free Bilayer
AL-3R	Blanket Guard - Large (24" x 36")/0.35mm Regular Lead
AL-3L	Blanket Guard - Large (24" x 36")/0.35mm Lightweight Lead
AL-3N	Blanket Guard - Large (24" x 36")/0.35mm Lead-Free Bilayer
AX-3R	Blanket Guard - X-Large (24" x 48")/0.35mm Regular Lead
AX-3L	Blanket Guard - X-Large (24" x 48")/0.35mm Lightweight Lead
AX-3N	Blanket Guard - X-Large (24" x 48")/0.35mm Lead-Free Bilayer
AS-5R	Blanket Guard - Small (18" x 18")/0.5mm Regular Lead
AS-5L	Blanket Guard - Small (18" x 18")/0.5mm Lightweight Lead
AS-5N	Blanket Guard - Small (18" x 18")/0.5mm Lead-Free Bilayer
AM-5R	Blanket Guard - Medium (24" x 24")/0.5mm Regular Lead
AM-5L	Blanket Guard - Medium (24" x 24")/0.5mm Lightweight Lead
AM-5N	Blanket Guard - Medium (24" x 24")/0.5mm Lead-Free Bilayer
AL-5R	Blanket Guard - Large (24" x 36")/0.5mm Regular Lead
AL-5L	Blanket Guard - Large (24" x 36")/0.5mm Lightweight Lead
AL-5N	Blanket Guard - Large (24" x 36")/0.5mm Lead-Free Bilayer
AX-5R	Blanket Guard - X-Large (24" x 48")/0.5mm Regular Lead
AX-5L	Blanket Guard - X-Large (24" x 48")/0.5mm Lightweight Lead
AX-5N	Blanket Guard - X-Large (24" x 48")/0.5mm Lead-Free Bilayer
BA-5R	Breast Guard - Adult Size/0.5mm Regular Lead
BA-5L	Breast Guard - Adult Size/0.5mm Lightweight Lead
BA-5N	Breast Guard - Adult Size/0.5mm Lead-Free Bilayer
BC-5R	Breast Guard - Child Size/0.5mm Regular Lead
BC-5L	Breast Guard - Child Size/0.5mm Lightweight Lead
BC-5N	Breast Guard - Child Size/0.5mm Lead-Free Bilayer
CC-5R	EZ Pediatric Front Apron - Child Size/0.5mm Regular Lead
CC-5L	EZ Pediatric Front Apron - Child Size/0.5mm Lightweight Lead
CC-5N	EZ Pediatric Front Apron - Child Size/0.5mm Lead-Free Bilayer
DA-3R	EZ Dental Drape - Adult Size/0.35mm Regular Lead
DA-3L	EZ Dental Drape - Adult Size/0.35mm Lightweight Lead
DA-3N	EZ Dental Drape - Adult Size/0.35mm Lead-Free Bilayer
DC-3R	EZ Dental Drape - Child Size/0.35mm Regular Lead
DC-3L	EZ Dental Drape - Child Size/0.35mm Lightweight Lead
DC-3N	EZ Dental Drape - Child Size/0.35mm Lead-Free Bilayer
EP-3R	EZ Front Apron - Petite/0.35mm Regular Lead
EP-3L	EZ Front Apron - Petite/0.35mm Lightweight Lead
EP-3N	EZ Front Apron - Petite/0.35mm Lead-Free Bilayer
ES-3R	EZ Front Apron - Small/0.35mm Regular Lead
ES-3L	EZ Front Apron - Small/0.35mm Lightweight Lead
ES-3N	EZ Front Apron - Small/0.35mm Lead-Free Bilayer
EM-3R	EZ Front Apron - Medium/0.35mm Regular Lead
EM-3L	EZ Front Apron - Medium/0.35mm Lightweight Lead
EM-3N	EZ Front Apron - Medium/0.35mm Lead-Free Bilayer
EL-3R	EZ Front Apron - Large/0.35mm Regular Lead
EL-3L	EZ Front Apron - Large/0.35mm Lightweight Lead
EL-3N	EZ Front Apron - Large/0.35mm Lead-Free Bilayer
EX-3R	EZ Front Apron - X-Large/0.35mm Regular Lead
EX-3L	EZ Front Apron - X-Large/0.35mm Lightweight Lead
EX-3N	EZ Front Apron - X-Large/0.35mm Lead-Free Bilayer

PART NUMBER	DESCRIPTION
EZ-3R	EZ Front Apron - 2XL/0.35mm Regular Lead
EZ-3L	EZ Front Apron - 2XL/0.35mm Lightweight Lead
EZ-3N	EZ Front Apron - 2XL/0.35mm Lead-Free Bilayer
E3-3R	EZ Front Apron - 3XL/0.35mm Regular Lead
E3-3L	EZ Front Apron - 3XL/0.35mm Lightweight Lead
E3-3N	EZ Front Apron - 3XL/0.35mm Lead-Free Bilayer
EP-5R	EZ Front Apron - Petite/0.5mm Regular Lead
EP-5L	EZ Front Apron - Petite/0.5mm Lightweight Lead
EP-5N	EZ Front Apron - Petite/0.5mm Lead-Free Bilayer
ES-5R	EZ Front Apron - Small/0.5mm Regular Lead
ES-5L	EZ Front Apron - Small/0.5mm Lightweight Lead
ES-5N	EZ Front Apron - Small/0.5mm Lead-Free Bilayer
EM-5R	EZ Front Apron - Medium/0.5mm Regular Lead
EM-5L	EZ Front Apron - Medium/0.5mm Lightweight Lead
EM-5N	EZ Front Apron - Medium/0.5mm Lead-Free Bilayer
EL-5R	EZ Front Apron - Large/0.5mm Regular Lead
EL-5L	EZ Front Apron - Large/0.5mm Lightweight Lead
EL-5N	EZ Front Apron - Large/0.5mm Lead-Free Bilayer
EX-5R	EZ Front Apron - X-Large/0.5mm Regular Lead
EX-5L	EZ Front Apron - X-Large/0.5mm Lightweight Lead
EX-5N	EZ Front Apron - X-Large/0.5mm Lead-Free Bilayer
EZ-5R	EZ Front Apron - 2XL/0.5mm Regular Lead
EZ-5L	EZ Front Apron - 2XL/0.5mm Lightweight Lead
EZ-5N	EZ Front Apron - 2XL/0.5mm Lead-Free Bilayer
E3-5R	EZ Front Apron - 3XL/0.5mm Regular Lead
E3-5L	EZ Front Apron - 3XL/0.5mm Lightweight Lead
E3-5N	EZ Front Apron - 3XL/0.5mm Lead-Free Bilayer
EZ BELT	EZ Belt - One Size
FLB-52	Flexible Lead Blocker - 5" x 12" (1mm Pb equivalency)
FLB-58	Flexible Lead Blocker - 5" x 8" (1mm Pb equivalency)
FLB-61	Flexible Lead Blocker - 6" x 10" (1mm Pb equivalency)
FLB-71	Flexible Lead Blocker - 7" x 11" (1mm Pb equivalency)
FLB-77	Flexible Lead Blocker - 7" x 17" (1mm Pb equivalency)
FLB-78	Flexible Lead Blocker Bundle (1 each of all 5 Sizes)
FP-3R	EZ Comfort-Flex Front Apron - Petite/0.35mm Regular Lead
FP-3L	EZ Comfort-Flex Front Apron - Petite/0.35mm Lightweight Lead
FP-3N	EZ Comfort-Flex Front Apron - Petite/0.35mm Lead-Free Bilayer
FS-3R	EZ Comfort-Flex Front Apron - Small/0.35mm Regular Lead
FS-3L	EZ Comfort-Flex Front Apron - Small/0.35mm Lightweight Lead
FS-3N	EZ Comfort-Flex Front Apron - Small/0.35mm Lead-Free Bilayer
FM-3R	EZ Comfort-Flex Front Apron - Medium/0.35mm Regular Lead
FM-3L	EZ Comfort-Flex Front Apron - Medium/0.35mm Lightweight Lead
FM-3N	EZ Comfort-Flex Front Apron - Medium/0.35mm Lead-Free Bilayer
FL-3R	EZ Comfort-Flex Front Apron - Large/0.35mm Regular Lead
FL-3L	EZ Comfort-Flex Front Apron - Large/0.35mm Lightweight Lead
FL-3N	EZ Comfort-Flex Front Apron - Large/0.35mm Lead-Free Bilayer
FX-3R	EZ Comfort-Flex Front Apron - X-Large/0.35mm Regular Lead
FX-3L	EZ Comfort-Flex Front Apron - X-Large/0.35mm Lightweight Lead
FX-3N	EZ Comfort-Flex Front Apron - X-Large/0.35mm Lead-Free Bilayer
F2-3R	EZ Comfort-Flex Front Apron - 2XL/0.35mm Regular Lead
F2-3L	EZ Comfort-Flex Front Apron - 2XL/0.35mm Lightweight Lead
F2-3N	EZ Comfort-Flex Front Apron - 2XL/0.35mm Lead-Free Bilayer
F3-3R	EZ Comfort-Flex Front Apron - 3XL/0.35mm Regular Lead
F3-3L	EZ Comfort-Flex Front Apron - 3XL/0.35mm Lightweight Lead
F3-3N	EZ Comfort-Flex Front Apron - 3XL/0.35mm Lead-Free Bilayer
FP-5R	EZ Comfort-Flex Front Apron - Petite/0.5mm Regular Lead
FP-5L	EZ Comfort-Flex Front Apron - Petite/0.5mm Lightweight Lead
FP-5N	EZ Comfort-Flex Front Apron - Petite/0.5mm Lead-Free Bilayer
FS-5R	EZ Comfort-Flex Front Apron - Small/0.5mm Regular Lead
FS-5L	EZ Comfort-Flex Front Apron - Small/0.5mm Lightweight Lead
FS-5N	EZ Comfort-Flex Front Apron - Small/0.5mm Lead-Free Bilayer
FM-5R	EZ Comfort-Flex Front Apron - Medium/0.5mm Regular Lead
FM-5L	EZ Comfort-Flex Front Apron - Medium/0.5mm Lightweight Lead
FM-5N	EZ Comfort-Flex Front Apron - Medium/0.5mm Lead-Free Bilayer
FL-5R	EZ Comfort-Flex Front Apron - Large/0.5mm Regular Lead
FL-5L	EZ Comfort-Flex Front Apron - Large/0.5mm Lightweight Lead
FL-5N	EZ Comfort-Flex Front Apron - Large/0.5mm Lead-Free Bilayer
FX-5R	EZ Comfort-Flex Front Apron - X-Large/0.5mm Regular Lead
FX-5L	EZ Comfort-Flex Front Apron - X-Large/0.5mm Lightweight Lead
FX-5N	EZ Comfort-Flex Front Apron - X-Large/0.5mm Lead-Free Bilayer
F2-5R	EZ Comfort-Flex Front Apron - 2XL/0.5mm Regular Lead
F2-5L	EZ Comfort-Flex Front Apron - 2XL/0.5mm Lightweight Lead
F2-5N	EZ Comfort-Flex Front Apron - 2XL/0.5mm Lead-Free Bilayer
F3-5R	EZ Comfort-Flex Front Apron - 3XL/0.5mm Regular Lead
F3-5L	EZ Comfort-Flex Front Apron - 3XL/0.5mm Lightweight Lead
F3-5N	EZ Comfort-Flex Front Apron - 3XL/0.5mm Lead-Free Bilayer
GS-5R	Gonadal Guard - Small/0.5mm Regular Lead
GS-5L	Gonadal Guard - Small/0.5mm Lightweight Lead
GS-5N	Gonadal Guard - Small/0.5mm Lead-Free Bilayer
GM-5R	Gonadal Guard - Medium/0.5mm Regular Lead
GM-5L	Gonadal Guard - Medium/0.5mm Lightweight Lead
GM-5N	Gonadal Guard - Medium/0.5mm Lead-Free Bilayer
GL-5R	Gonadal Guard - Large/0.5mm Regular Lead
GL-5L	Gonadal Guard - Large/0.5mm Lightweight Lead
GL-5N	Gonadal Guard - Large/0.5mm Lead-Free Bilayer
GB-5R	Gonadal Guard - Bundle/0.5mm Regular Lead (1 each - S, M, L)
GB-5L	Gonadal Guard - Bundle/0.5mm Lightweight Lead (1 each - S, M, L)
GB-5N	Gonadal Guard - Bundle/0.5mm Lead-Free Bilayer (1 each - S, M, L)
H1978BL	Mobile Z-Base Apron Storage Rack
H1978BL10	Mobile Z-Base Apron Storage Rack with 10 Steel Apron Hangers
HO-2N-33-K-V-N	EZ Sleeve - One Size/0.25mm Lead-Free Bilayer
IS-5R	Scolio Guard - Standard/0.5mm Regular Lead
JP-3R	EZ Full Wrap Partial Overlap Vest - Petite/0.35mm Regular Lead
JP-3L	EZ Full Wrap Partial Overlap Vest - Petite/0.35mm Lightweight Lead



PART NUMBER

DESCRIPTION

JP-3N	EZ Full Wrap Partial Overlap Vest - Petite/0.35mm Lead-Free Bilayer
JS-3R	EZ Full Wrap Partial Overlap Vest - Small/0.35mm Regular Lead
JS-3L	EZ Full Wrap Partial Overlap Vest - Small/0.35mm Lightweight Lead
JS-3N	EZ Full Wrap Partial Overlap Vest - Small/0.35mm Lead-Free Bilayer
JM-3R	EZ Full Wrap Partial Overlap Vest - Medium/0.35mm Regular Lead
JM-3L	EZ Full Wrap Partial Overlap Vest - Medium/0.35mm Lightweight Lead
JM-3N	EZ Full Wrap Partial Overlap Vest - Medium/0.35mm Lead-Free Bilayer
JL-3R	EZ Full Wrap Partial Overlap Vest - Large/0.35mm Regular Lead
JL-3L	EZ Full Wrap Partial Overlap Vest - Large/0.35mm Lightweight Lead
JL-3N	EZ Full Wrap Partial Overlap Vest - Large/0.35mm Lead-Free Bilayer
JX-3R	EZ Full Wrap Partial Overlap Vest - X-Large/0.35mm Regular Lead
JX-3L	EZ Full Wrap Partial Overlap Vest - X-Large/0.35mm Lightweight Lead
JX-3N	EZ Full Wrap Partial Overlap Vest - X-Large/0.35mm Lead-Free Bilayer
J2-3R	EZ Full Wrap Partial Overlap Vest - 2XL/0.35mm Regular Lead
J2-3L	EZ Full Wrap Partial Overlap Vest - 2XL/0.35mm Lightweight Lead
J2-3N	EZ Full Wrap Partial Overlap Vest - 2XL/0.35mm Lead-Free Bilayer
J3-3R	EZ Full Wrap Partial Overlap Vest - 3XL/0.35mm Regular Lead
J3-3L	EZ Full Wrap Partial Overlap Vest - 3XL/0.35mm Lightweight Lead
J3-3N	EZ Full Wrap Partial Overlap Vest - 3XL/0.35mm Lead-Free Bilayer
JP-5R	EZ Full Wrap Partial Overlap Vest - Petite/0.5mm Regular Lead
JP-5L	EZ Full Wrap Partial Overlap Vest - Petite/0.5mm Lightweight Lead
JP-5N	EZ Full Wrap Partial Overlap Vest - Petite/0.5mm Lead-Free Bilayer
JS-5R	EZ Full Wrap Partial Overlap Vest - Small/0.5mm Regular Lead
JS-5L	EZ Full Wrap Partial Overlap Vest - Small/0.5mm Lightweight Lead
JS-5N	EZ Full Wrap Partial Overlap Vest - Small/0.5mm Lead-Free Bilayer
JM-5R	EZ Full Wrap Partial Overlap Vest - Medium/0.5mm Regular Lead
JM-5L	EZ Full Wrap Partial Overlap Vest - Medium/0.5mm Lightweight Lead
JM-5N	EZ Full Wrap Partial Overlap Vest - Medium/0.5mm Lead-Free Bilayer
JL-5R	EZ Full Wrap Partial Overlap Vest - Large/0.5mm Regular Lead
JL-5L	EZ Full Wrap Partial Overlap Vest - Large/0.5mm Lightweight Lead
JL-5N	EZ Full Wrap Partial Overlap Vest - Large/0.5mm Lead-Free Bilayer
JX-5R	EZ Full Wrap Partial Overlap Vest - X-Large/0.5mm Regular Lead
JX-5L	EZ Full Wrap Partial Overlap Vest - X-Large/0.5mm Lightweight Lead
JX-5N	EZ Full Wrap Partial Overlap Vest - X-Large/0.5mm Lead-Free Bilayer
J2-5R	EZ Full Wrap Partial Overlap Vest - 2XL/0.5mm Regular Lead
J2-5L	EZ Full Wrap Partial Overlap Vest - 2XL/0.5mm Lightweight Lead
J2-5N	EZ Full Wrap Partial Overlap Vest - 2XL/0.5mm Lead-Free Bilayer
J3-5R	EZ Full Wrap Partial Overlap Vest - 3XL/0.5mm Regular Lead
J3-5L	EZ Full Wrap Partial Overlap Vest - 3XL/0.5mm Lightweight Lead
J3-5N	EZ Full Wrap Partial Overlap Vest - 3XL/0.5mm Lead-Free Bilayer
LAP-BNDL-B	Lap Guard Half Apron Room Bundle - Buckle Closure (1 Each - S, M, L, XL/Set colors/0.5mm Reg. Lead; ARP-02)
LAP-BNDL-B-E	Lap Guard Half Apron Room Bundle - Buckle Closure & Embroidery (1 each - S, M, L, XL/Set colors/0.5mm Reg. Lead; ARP-02)
LAP-BNDL-V	Lap Guard Half Apron Room Bundle - Hook & Loop Closure (1 each - S, M, L, XL/Set colors/0.5mm Reg. Lead; ARP-02)
LAP-BNDL-V-E	Lap Guard Half Apron Room Bundle - Hook & Loop Closure & Embroidery (1 each - S, M, L, XL/Set colors/0.5mm Reg. Lead; ARP-02)
LP-3R	Lap Guard Half Apron - Petite/0.35mm Regular Lead
LP-3L	Lap Guard Half Apron - Petite/0.35mm Lightweight Lead
LP-3N	Lap Guard Half Apron - Petite/0.35mm Lead-Free Bilayer
LS-3R	Lap Guard Half Apron - Small/0.35mm Regular Lead
LS-3L	Lap Guard Half Apron - Small/0.35mm Lightweight Lead
LS-3N	Lap Guard Half Apron - Small/0.35mm Lead-Free Bilayer
LM-3R	Lap Guard Half Apron - Medium/0.35mm Regular Lead
LM-3L	Lap Guard Half Apron - Medium/0.35mm Lightweight Lead
LM-3N	Lap Guard Half Apron - Medium/0.35mm Lead-Free Bilayer
LL-3R	Lap Guard Half Apron - Large/0.35mm Regular Lead
LL-3L	Lap Guard Half Apron - Large/0.35mm Lightweight Lead
LL-3N	Lap Guard Half Apron - Large/0.35mm Lead-Free Bilayer
LX-3R	Lap Guard Half Apron - X-Large/0.35mm Regular Lead
LX-3L	Lap Guard Half Apron - X-Large/0.35mm Lightweight Lead
LX-3N	Lap Guard Half Apron - X-Large/0.35mm Lead-Free Bilayer
L2-3R	Lap Guard Half Apron - 2XL/0.35mm Regular Lead
L2-3L	Lap Guard Half Apron - 2XL/0.35mm Lightweight Lead
L2-3N	Lap Guard Half Apron - 2XL/0.35mm Lead-Free Bilayer
LP-5R	Lap Guard Half Apron - Petite/0.5mm Regular Lead
LP-5L	Lap Guard Half Apron - Petite/0.5mm Lightweight Lead
LP-5N	Lap Guard Half Apron - Petite/0.5mm Lead-Free Bilayer
LS-5R	Lap Guard Half Apron - Small/0.5mm Regular Lead
LS-5L	Lap Guard Half Apron - Small/0.5mm Lightweight Lead
LS-5N	Lap Guard Half Apron - Small/0.5mm Lead-Free Bilayer
LM-5R	Lap Guard Half Apron - Medium/0.5mm Regular Lead
LM-5L	Lap Guard Half Apron - Medium/0.5mm Lightweight Lead
LM-5N	Lap Guard Half Apron - Medium/0.5mm Lead-Free Bilayer
LL-5R	Lap Guard Half Apron - Large/0.5mm Regular Lead
LL-5L	Lap Guard Half Apron - Large/0.5mm Lightweight Lead
LL-5N	Lap Guard Half Apron - Large/0.5mm Lead-Free Bilayer
LX-5R	Lap Guard Half Apron - X-Large/0.5mm Regular Lead
LX-5L	Lap Guard Half Apron - X-Large/0.5mm Lightweight Lead
LX-5N	Lap Guard Half Apron - X-Large/0.5mm Lead-Free Bilayer
L2-5R	Lap Guard Half Apron - 2XL/0.5mm Regular Lead
L2-5L	Lap Guard Half Apron - 2XL/0.5mm Lightweight Lead
L2-5N	Lap Guard Half Apron - 2XL/0.5mm Lead-Free Bilayer
MP-3L	EZ Full Wrap Apron - Petite/0.35mm Lightweight Lead
MP-3N	EZ Full Wrap Apron - Petite/0.35mm Lead-Free Bilayer
MS-3L	EZ Full Wrap Apron - Small/0.35mm Lightweight Lead
MS-3N	EZ Full Wrap Apron - Small/0.35mm Lead-Free Bilayer
MM-3L	EZ Full Wrap Apron - Medium/0.35mm Lightweight Lead
MM-3N	EZ Full Wrap Apron - Medium/0.35mm Lead-Free Bilayer
ML-3L	EZ Full Wrap Apron - Large/0.35mm Lightweight Lead
ML-3N	EZ Full Wrap Apron - Large/0.35mm Lead-Free Bilayer
MX-3L	EZ Full Wrap Apron - X-Large/0.35mm Lightweight Lead
MX-3N	EZ Full Wrap Apron - X-Large/0.35mm Lead-Free Bilayer
M2-3L	EZ Full Wrap Apron - 2XL/0.35mm Lightweight Lead
M2-3N	EZ Full Wrap Apron - 2XL/0.35mm Lead-Free Bilayer
M3-3L	EZ Full Wrap Apron - 3XL/0.35mm Lightweight Lead
M3-3N	EZ Full Wrap Apron - 3XL/0.35mm Lead-Free Bilayer



PART NUMBER	DESCRIPTION
MP-5L	EZ Full Wrap Apron - Petite/0.5mm Lightweight Lead
MP-5N	EZ Full Wrap Apron - Petite/0.5mm Lead-Free Bilayer
MS-5L	EZ Full Wrap Apron - Small/0.5mm Lightweight Lead
MS-5N	EZ Full Wrap Apron - Small/0.5mm Lead-Free Bilayer
MM-5L	EZ Full Wrap Apron - Medium/0.5mm Lightweight Lead
MM-5N	EZ Full Wrap Apron - Medium/0.5mm Lead-Free Bilayer
ML-5L	EZ Full Wrap Apron - Large/0.5mm Lightweight Lead
ML-5N	EZ Full Wrap Apron - Large/0.5mm Lead-Free Bilayer
MX-5L	EZ Full Wrap Apron - X-Large/0.5mm Lightweight Lead
MX-5N	EZ Full Wrap Apron - X-Large/0.5mm Lead-Free Bilayer
M2-5L	EZ Full Wrap Apron - 2XL/0.5mm Lightweight Lead
M2-5N	EZ Full Wrap Apron - 2XL/0.5mm Lead-Free Bilayer
M3-5L	EZ Full Wrap Apron - 3XL/0.5mm Lightweight Lead
M3-5N	EZ Full Wrap Apron - 3XL/0.5mm Lead-Free Bilayer
MB2430G20	Mobile Barrier - 24" x 30" Glass Window - 2.0mm Pb Protection
Model160-BX	Model 1 FreeGuard (22mm) Glove Size 6 - Box of 5 Pair
Model160-CS	Model 1 FreeGuard (22mm) Glove Size 6 - Case of 10 Boxes (50 Pairs)
Model165-BX	Model 1 FreeGuard (22mm) Glove Size 6.5 - Box of 5 Pair
Model165-CS	Model 1 FreeGuard (22mm) Glove Size 6.5 - Case of 10 Boxes (50 Pairs)
Model170-BX	Model 1 FreeGuard (22mm) Glove Size 7 - Box of 5 Pair
Model170-CS	Model 1 FreeGuard (22mm) Glove Size 7 - Case of 10 Boxes (50 Pairs)
Model175-BX	Model 1 FreeGuard (22mm) Glove Size 7.5 - Box of 5 Pair
Model175-CS	Model 1 FreeGuard (22mm) Glove Size 7.5 - Case of 10 Boxes (50 Pairs)
Model180-BX	Model 1 FreeGuard (22mm) Glove Size 8 - Box of 5 Pair
Model180-CS	Model 1 FreeGuard (22mm) Glove Size 8 - Case of 10 Boxes (50 Pairs)
Model185-BX	Model 1 FreeGuard (22mm) Glove Size 8.5 - Box of 5 Pair
Model185-CS	Model 1 FreeGuard (22mm) Glove Size 8.5 - Case of 10 Boxes (50 Pairs)
Model190-BX	Model 1 FreeGuard (22mm) Glove Size 9 - Box of 5 Pair
Model190-CS	Model 1 FreeGuard (22mm) Glove Size 9 - Case of 10 Boxes (50 Pairs)
Model260-CS	Model 2 FreeGuard (30mm) Glove Size 6 - Case of 10 Boxes (50 Pairs)
Model265-CS	Model 2 FreeGuard (30mm) Glove Size 6.5 - Case of 10 Boxes (50 Pairs)
Model270-CS	Model 2 FreeGuard (30mm) Glove Size 7 - Case of 10 Boxes (50 Pairs)
Model275-CS	Model 2 FreeGuard (30mm) Glove Size 7.5 - Case of 10 Boxes (50 Pairs)
Model280-CS	Model 2 FreeGuard (30mm) Glove Size 8 - Case of 10 Boxes (50 Pairs)
Model285-CS	Model 2 FreeGuard (30mm) Glove Size 8.5 - Case of 10 Boxes (50 Pairs)
Model290-CS	Model 2 FreeGuard (30mm) Glove Size 9 - Case of 10 Boxes (50 Pairs)
NA-3R	EZ Panoramic Dental Drape - Adult Size/0.35mm Regular Lead
NA-3L	EZ Panoramic Dental Drape - Adult Size/0.35mm Lightweight Lead
NA-3N	EZ Panoramic Dental Drape - Adult Size/0.35mm Lead-Free Bilayer
NON-SLIP LINING	No-Slip Lining for Skirts
OP-3R	EZ Release Comfort OR Front Apron - Petite/0.35mm Regular Lead
OP-3L	EZ Release Comfort OR Front Apron - Petite/0.35mm Lightweight Lead
OP-3N	EZ Release Comfort OR Front Apron - Petite/0.35mm Lead-Free Bilayer
OS-3R	EZ Release Comfort OR Front Apron - Small/0.35mm Regular Lead
OS-3L	EZ Release Comfort OR Front Apron - Small/0.35mm Lightweight Lead
OS-3N	EZ Release Comfort OR Front Apron - Small/0.35mm Lead-Free Bilayer
OM-3R	EZ Release Comfort OR Front Apron - Medium/0.35mm Regular Lead
OM-3L	EZ Release Comfort OR Front Apron - Medium/0.35mm Lightweight Lead
OM-3N	EZ Release Comfort OR Front Apron - Medium/0.35mm Lead-Free Bilayer
OL-3R	EZ Release Comfort OR Front Apron - Large/0.35mm Regular Lead
OL-3L	EZ Release Comfort OR Front Apron - Large/0.35mm Lightweight Lead
OL-3N	EZ Release Comfort OR Front Apron - Large/0.35mm Lead-Free Bilayer
OX-3R	EZ Release Comfort OR Front Apron - X-Large/0.35mm Regular Lead
OX-3L	EZ Release Comfort OR Front Apron - X-Large/0.35mm Lightweight Lead
OX-3N	EZ Release Comfort OR Front Apron - X-Large/0.35mm Lead-Free Bilayer
O2-3R	EZ Release Comfort OR Front Apron - 2XL/0.35mm Regular Lead
O2-3L	EZ Release Comfort OR Front Apron - 2XL/0.35mm Lightweight Lead
O2-3N	EZ Release Comfort OR Front Apron - 2XL/0.35mm Lead-Free Bilayer
O3-3R	EZ Release Comfort OR Front Apron - 3XL/0.35mm Regular Lead
O3-3L	EZ Release Comfort OR Front Apron - 3XL/0.35mm Lightweight Lead
O3-3N	EZ Release Comfort OR Front Apron - 3XL/0.35mm Lead-Free Bilayer
OP-5R	EZ Release Comfort OR Front Apron - Petite/0.5mm Regular Lead
OP-5L	EZ Release Comfort OR Front Apron - Petite/0.5mm Lightweight Lead
OP-5N	EZ Release Comfort OR Front Apron - Petite/0.5mm Lead-Free Bilayer
OS-5R	EZ Release Comfort OR Front Apron - Small/0.5mm Regular Lead
OS-5L	EZ Release Comfort OR Front Apron - Small/0.5mm Lightweight Lead
OS-5N	EZ Release Comfort OR Front Apron - Small/0.5mm Lead-Free Bilayer
OM-5R	EZ Release Comfort OR Front Apron - Medium/0.5mm Regular Lead
OM-5L	EZ Release Comfort OR Front Apron - Medium/0.5mm Lightweight Lead
OM-5N	EZ Release Comfort OR Front Apron - Medium/0.5mm Lead-Free Bilayer
OL-5R	EZ Release Comfort OR Front Apron - Large/0.5mm Regular Lead
OL-5L	EZ Release Comfort OR Front Apron - Large/0.5mm Lightweight Lead
OL-5N	EZ Release Comfort OR Front Apron - Large/0.5mm Lead-Free Bilayer
OX-5R	EZ Release Comfort OR Front Apron - X-Large/0.5mm Regular Lead
OX-5L	EZ Release Comfort OR Front Apron - X-Large/0.5mm Lightweight Lead
OX-5N	EZ Release Comfort OR Front Apron - X-Large/0.5mm Lead-Free Bilayer
O2-5R	EZ Release Comfort OR Front Apron - 2XL/0.5mm Regular Lead
O2-5L	EZ Release Comfort OR Front Apron - 2XL/0.5mm Lightweight Lead
O2-5N	EZ Release Comfort OR Front Apron - 2XL/0.5mm Lead-Free Bilayer
O3-5R	EZ Release Comfort OR Front Apron - 3XL/0.5mm Regular Lead
O3-5L	EZ Release Comfort OR Front Apron - 3XL/0.5mm Lightweight Lead
O3-5N	EZ Release Comfort OR Front Apron - 3XL/0.5mm Lead-Free Bilayer
PAD-R2	Wall Mounted Table Pad Storage Rack
PATCH	Removable Embroidery Patch
PS-1L	EZ Pregnancy Front Apron - Standard Size/1.0mm Lightweight Lead
PS-1N	EZ Pregnancy Front Apron - Standard Size/1.0mm Lead-Free Bilayer
PT-1L	EZ Pregnancy Front Apron - Full Size/1.0mm Lightweight Lead
PT-1N	EZ Pregnancy Front Apron - Full Size/1.0mm Lead-Free Bilayer
QS-2N	EZ Cap - Small/2.0mm Lead-Free Bilayer
QM-2N	EZ Cap - Medium/2.0mm Lead-Free Bilayer
QL-2N	EZ Cap - Large/2.0mm Lead-Free Bilayer
RPAK1	Protective Apparel Recycling Box - 1 (Single) Box [Non-Discounted item]
RPAK5	Protective Apparel Recycling Box - 5 Boxes [Non-Discounted item]
RG-1205-BK	Rugged Radiation Safety Glasses - Black

PART NUMBER	DESCRIPTION
RG-1205-BL	Rugged Radiation Safety Glasses - Blue
RG-15011-BKC-50SS	Premium Radiation Safety Glasses - Black Crystal
RG-15011-BKY-50SS	Premium Radiation Safety Glasses - Black Green
RG-15011-CR-50SS	Premium Radiation Safety Glasses - Crystal Red
RG-15011-CC-50SS	Premium Radiation Safety Glasses - Crystal Clear
RG-15011-NVC-50SS	Premium Radiation Safety Glasses - Navy Clear
RG-16001-BKBL	Deluxe Radiation Safety Glasses - Black/Blue
RG-208-BK	Ultra-Guard Radiation Safety Glasses - Plano Lens (Black Frame)
RG-208-S	Ultra-Guard Radiation Safety Glasses - Plano Lens (Silver Frame)
RG-208-R	Ultra-Guard Radiation Safety Glasses - Plano Lens (Red Frame)
RG-208-PG	Ultra-Guard Radiation Safety Glasses - Plano Lens (Purple/Gray Frame)
RG-208-BY	Ultra-Guard Radiation Safety Glasses - Plano Lens (Blue/Yellow Frame)
RG-208-PK	Ultra-Guard Radiation Safety Glasses - Plano Lens (Pink Frame)
RG-33-BK-50SS	Cover-Guard Radiation Safety Glasses - Plano Lens (Black Frame)
RG-33-T-50SS	Cover-Guard Radiation Safety Glasses - Plano Lens (Tortoise Frame)
RG-33-W-50SS	Cover-Guard Radiation Safety Glasses - Plano Lens (White Frame)
RG-F10-BB-50SS	Economy Radiation Safety Glasses - Blue Black
RG-F10-BY-50SS	Economy Radiation Safety Glasses - Black Yellow
RG-F10-CLR-50SS	Economy Radiation Safety Glasses - Black/Yellow Clear
RG-F126-BK-50SS	Standard Radiation Safety Glasses - Black
RG-NI-FJ1994-060	Nike Brazen Boost Radiation Safety Glasses - Matte Anthracite
RG-NI-FJ1978-451	Nike Brazen Boost Radiation Safety Glasses - Matte Dark Obsidian
RG-NI-FJ1975-010	Nike Brazen Boost Radiation Safety Glasses - Matte Black/White
RG-NI-FJ1975-021	Nike Brazen Boost Radiation Safety Glasses - Matte Dark Gray/White
RG-NI-FJ1985-012	Nike Brazen Shadow Radiation Safety Glasses - Dark Gray/Gray
RG-NI-FJ1987-451	Nike Brazen Shadow Radiation Safety Glasses - Matte Dark Obsidian
RG-NI-FJ1985-060	Nike Brazen Shadow Radiation Safety Glasses - Matte Anthracite/Gray
RG-NI-FJ1985-010	Nike Brazen Shadow Radiation Safety Glasses - Matte Black/White
RG-NI-FJ1985-021	Nike Brazen Shadow Radiation Safety Glasses - Matte Dark Gray/Red
RG-NI-EV0571-001	Nike Brazen Radiation Safety Glasses - Black
RG-NI-EV0758-049	Nike Brazen Boost Radiation Safety Glasses - Matte Black/Military Blue
RG-Q100-BK-50SS	Convertible Radiation Safety Glasses - Black/Clear [Large]
RG-Q200-BK-50SS	Convertible Radiation Safety Glasses - Glossy Black [Medium]
RG-Q200-BKPK-50SS	Convertible Radiation Safety Glasses - Blue/Pink [Medium]
RG-Q200-PUR-50SS	Convertible Radiation Safety Glasses - Purple [Medium]
RG-Q300-BK-50SS	Convertible Radiation Safety Glasses - Matte Black [Small]
RR160-BX	RR1 XGuard Glove Size 6 - Box of 5 Pairs
RR160-CS	RR1 XGuard Glove Size 6 - Case of 10 Boxes (50 Pairs)
RR165-BX	RR1 XGuard Glove Size 6.5 - Box of 5 Pairs
RR165-CS	RR1 XGuard Glove Size 6.5 - Case of 10 Boxes (50 Pairs)
RR170-BX	RR1 XGuard Glove Size 7 - Box of 5 Pairs
RR170-CS	RR1 XGuard Glove Size 7 - Case of 10 Boxes (50 Pairs)
RR175-BX	RR1 XGuard Glove Size 7.5 - Box of 5 Pairs
RR175-CS	RR1 XGuard Glove Size 7.5 - Case of 10 Boxes (50 Pairs)
RR180-BX	RR1 XGuard Glove Size 8 - Box of 5 Pairs
RR180-CS	RR1 XGuard Glove Size 8 - Case of 10 Boxes (50 Pairs)
RR185-BX	RR1 XGuard Glove Size 8.5 - Box of 5 Pairs
RR185-CS	RR1 XGuard Glove Size 8.5 - Case of 10 Boxes (50 Pairs)
RR190-BX	RR1 XGuard Glove Size 9 - Box of 5 Pairs
RR190-CS	RR1 XGuard Glove Size 9 - Case of 10 Boxes (50 Pairs)
RR260-CS	RR2 XGuard Glove Size 6 - Case of 10 Boxes (50 Pairs)
RR265-CS	RR2 XGuard Glove Size 6.5 - Case of 10 Boxes (50 Pairs)
RR270-CS	RR2 XGuard Glove Size 7 - Case of 10 Boxes (50 Pairs)
RR275-CS	RR2 XGuard Glove Size 7.5 - Case of 10 Boxes (50 Pairs)
RR280-CS	RR2 XGuard Glove Size 8 - Case of 10 Boxes (50 Pairs)
RR285-CS	RR2 XGuard Glove Size 8.5 - Case of 10 Boxes (50 Pairs)
RR290-CS	RR2 XGuard Glove Size 9 - Case of 10 Boxes (50 Pairs)
RR360-CS	RR3 XGuard Glove Size 6 - Case of 10 Boxes (50 Pairs)
RR365-CS	RR3 XGuard Glove Size 6.5 - Case of 10 Boxes (50 Pairs)
RR370-CS	RR3 XGuard Glove Size 7 - Case of 10 Boxes (50 Pairs)
RR375-CS	RR3 XGuard Glove Size 7.5 - Case of 10 Boxes (50 Pairs)
RR380-CS	RR3 XGuard Glove Size 8 - Case of 10 Boxes (50 Pairs)
RR385-CS	RR3 XGuard Glove Size 8.5 - Case of 10 Boxes (50 Pairs)
RR390-CS	RR3 XGuard Glove Size 9 - Case of 10 Boxes (50 Pairs)
RX-1L	EZ Pregnancy Lap Guard Half Apron - 1.0mm Lightweight Lead
RX-1N	EZ Pregnancy Lap Guard Half Apron - 1.0mm Lead-Free Bilayer
SP-3R	EZ Full Wrap Skirt - Petite/0.35mm Regular Lead
SP-3L	EZ Full Wrap Skirt - Petite/0.35mm Lightweight Lead
SP-3N	EZ Full Wrap Skirt - Petite/0.35mm Lead-Free Bilayer
SS-3R	EZ Full Wrap Skirt - Small/0.35mm Regular Lead
SS-3L	EZ Full Wrap Skirt - Small/0.35mm Lightweight Lead
SS-3N	EZ Full Wrap Skirt - Small/0.35mm Lead-Free Bilayer
SM-3R	EZ Full Wrap Skirt - Medium/0.35mm Regular Lead
SM-3L	EZ Full Wrap Skirt - Medium/0.35mm Lightweight Lead
SM-3N	EZ Full Wrap Skirt - Medium/0.35mm Lead-Free Bilayer
SL-3R	EZ Full Wrap Skirt - Large/0.35mm Regular Lead
SL-3L	EZ Full Wrap Skirt - Large/0.35mm Lightweight Lead
SL-3N	EZ Full Wrap Skirt - Large/0.35mm Lead-Free Bilayer
SP-5R	EZ Full Wrap Skirt - Petite/0.5mm Regular Lead
SP-5L	EZ Full Wrap Skirt - Petite/0.5mm Lightweight Lead
SP-5N	EZ Full Wrap Skirt - Petite/0.5mm Lead-Free Bilayer
SS-5R	EZ Full Wrap Skirt - Small/0.5mm Regular Lead
SS-5L	EZ Full Wrap Skirt - Small/0.5mm Lightweight Lead
SS-5N	EZ Full Wrap Skirt - Small/0.5mm Lead-Free Bilayer
SM-5R	EZ Full Wrap Skirt - Medium/0.5mm Regular Lead
SM-5L	EZ Full Wrap Skirt - Medium/0.5mm Lightweight Lead
SM-5N	EZ Full Wrap Skirt - Medium/0.5mm Lead-Free Bilayer
SL-5R	EZ Full Wrap Skirt - Large/0.5mm Regular Lead
SL-5L	EZ Full Wrap Skirt - Large/0.5mm Lightweight Lead
SL-5N	EZ Full Wrap Skirt - Large/0.5mm Lead-Free Bilayer
SX-3R	EZ Full Wrap Skirt - X-Large/0.35mm Regular Lead
SX-3L	EZ Full Wrap Skirt - X-Large/0.35mm Lightweight Lead
SX-3N	EZ Full Wrap Skirt - X-Large/0.35mm Lead-Free Bilayer
SZ-3R	EZ Full Wrap Skirt - 2XL/0.35mm Regular Lead



PART NUMBER	DESCRIPTION
S2-3L	EZ Full Wrap Skirt - 2XL/0.35mm Lightweight Lead
S2-3N	EZ Full Wrap Skirt - 2XL/0.35mm Lead-Free Bilayer
S3-3R	EZ Full Wrap Skirt - 3XL/0.35mm Regular Lead
S3-3L	EZ Full Wrap Skirt - 3XL/0.35mm Lightweight Lead
S3-3N	EZ Full Wrap Skirt - 3XL/0.35mm Lead-Free Bilayer
SP-5R	EZ Full Wrap Skirt - Petite/0.5mm Regular Lead
SP-5L	EZ Full Wrap Skirt - Petite/0.5mm Lightweight Lead
SP-5N	EZ Full Wrap Skirt - Petite/0.5mm Lead-Free Bilayer
SS-5R	EZ Full Wrap Skirt - Small/0.5mm Regular Lead
SS-5L	EZ Full Wrap Skirt - Small/0.5mm Lightweight Lead
SS-5N	EZ Full Wrap Skirt - Small/0.5mm Lead-Free Bilayer
SM-5R	EZ Full Wrap Skirt - Medium/0.5mm Regular Lead
SM-5L	EZ Full Wrap Skirt - Medium/0.5mm Lightweight Lead
SM-5N	EZ Full Wrap Skirt - Medium/0.5mm Lead-Free Bilayer
SL-5R	EZ Full Wrap Skirt - Large/0.5mm Regular Lead
SL-5L	EZ Full Wrap Skirt - Large/0.5mm Lightweight Lead
SL-5N	EZ Full Wrap Skirt - Large/0.5mm Lead-Free Bilayer
SX-5R	EZ Full Wrap Skirt - X-Large/0.5mm Regular Lead
SX-5L	EZ Full Wrap Skirt - X-Large/0.5mm Lightweight Lead
SX-5N	EZ Full Wrap Skirt - X-Large/0.5mm Lead-Free Bilayer
S2-5R	EZ Full Wrap Skirt - 2XL/0.5mm Regular Lead
S2-5L	EZ Full Wrap Skirt - 2XL/0.5mm Lightweight Lead
S2-5N	EZ Full Wrap Skirt - 2XL/0.5mm Lead-Free Bilayer
S3-5R	EZ Full Wrap Skirt - 3XL/0.5mm Regular Lead
S3-5L	EZ Full Wrap Skirt - 3XL/0.5mm Lightweight Lead
S3-5N	EZ Full Wrap Skirt - 3XL/0.5mm Lead-Free Bilayer
SUSPENDERS-SMALL	EZ Suspenders - Small 14.5" - 26.5"
SUSPENDERS-LARGE	EZ Suspenders - Large 19.75" - 37.5"
TS-3R	Thyroid Guard - Full/0.35mm Regular Lead
TS-3L	Thyroid Guard - Full/0.35mm Lightweight Lead
TS-3N	Thyroid Guard - Full/0.35mm Lead-Free Bilayer
TS-5R	Thyroid Guard - Full/0.5mm Regular Lead
TS-5L	Thyroid Guard - Full/0.5mm Lightweight Lead
TS-5N	Thyroid Guard - Full/0.5mm Lead-Free Bilayer
TH-3R	Thyroid Guard - Mid-Binding/0.35mm Regular Lead
TH-3L	Thyroid Guard - Mid-Binding/0.35mm Lightweight Lead
TH-3N	Thyroid Guard - Mid-Binding/0.35mm Lead-Free Bilayer
TH-5R	Thyroid Guard - Mid-Binding/0.5mm Regular Lead
TH-5L	Thyroid Guard - Mid-Binding/0.5mm Lightweight Lead
TH-5N	Thyroid Guard - Mid-Binding/0.5mm Lead-Free Bilayer
TN-3R	Thyroid Guard - No Binding/0.35mm Regular Lead
TN-3L	Thyroid Guard - No Binding/0.35mm Lightweight Lead
TN-3N	Thyroid Guard - No Binding/0.35mm Lead-Free Bilayer
TN-5R	Thyroid Guard - No Binding/0.5mm Regular Lead
TN-5L	Thyroid Guard - No Binding/0.5mm Lightweight Lead
TN-5N	Thyroid Guard - No Binding/0.5mm Lead-Free Bilayer
TM-5R	Thyroid Guard - Mammography/0.5mm Regular Lead
TM-5L	Thyroid Guard - Mammography/0.5mm Lightweight Lead
TM-5N	Thyroid Guard - Mammography/0.5mm Lead-Free Bilayer
TP-5R	Thyroid Guard - Pediatric/0.5mm Regular Lead
TP-5L	Thyroid Guard - Pediatric/0.5mm Lightweight Lead
TP-5N	Thyroid Guard - Pediatric/0.5mm Lead-Free Bilayer
UP-3R	EZ Release Surgery Front Apron - Petite/0.35mm Regular Lead
UP-3L	EZ Release Surgery Front Apron - Petite/0.35mm Lightweight Lead
UP-3N	EZ Release Surgery Front Apron - Petite/0.35mm Lead-Free Bilayer
US-3R	EZ Release Surgery Front Apron - Small/0.35mm Regular Lead
US-3L	EZ Release Surgery Front Apron - Small/0.35mm Lightweight Lead
US-3N	EZ Release Surgery Front Apron - Small/0.35mm Lead-Free Bilayer
UM-3R	EZ Release Surgery Front Apron - Medium/0.35mm Regular Lead
UM-3L	EZ Release Surgery Front Apron - Medium/0.35mm Lightweight Lead
UM-3N	EZ Release Surgery Front Apron - Medium/0.35mm Lead-Free Bilayer
UL-3R	EZ Release Surgery Front Apron - Large/0.35mm Regular Lead
UL-3L	EZ Release Surgery Front Apron - Large/0.35mm Lightweight Lead
UL-3N	EZ Release Surgery Front Apron - Large/0.35mm Lead-Free Bilayer
UX-3R	EZ Release Surgery Front Apron - X-Large/0.35mm Regular Lead
UX-3L	EZ Release Surgery Front Apron - X-Large/0.35mm Lightweight Lead
UX-3N	EZ Release Surgery Front Apron - X-Large/0.35mm Lead-Free Bilayer
U2-3R	EZ Release Surgery Front Apron - 2XL/0.35mm Regular Lead
U2-3L	EZ Release Surgery Front Apron - 2XL/0.35mm Lightweight Lead
U2-3N	EZ Release Surgery Front Apron - 2XL/0.35mm Lead-Free Bilayer
U3-3R	EZ Release Surgery Front Apron - 3XL/0.35mm Regular Lead
U3-3L	EZ Release Surgery Front Apron - 3XL/0.35mm Lightweight Lead
U3-3N	EZ Release Surgery Front Apron - 3XL/0.35mm Lead-Free Bilayer
UP-5R	EZ Release Surgery Front Apron - Petite/0.5mm Regular Lead
UP-5L	EZ Release Surgery Front Apron - Petite/0.5mm Lightweight Lead
UP-5N	EZ Release Surgery Front Apron - Petite/0.5mm Lead-Free Bilayer
US-5R	EZ Release Surgery Front Apron - Small/0.5mm Regular Lead
US-5L	EZ Release Surgery Front Apron - Small/0.5mm Lightweight Lead
US-5N	EZ Release Surgery Front Apron - Small/0.5mm Lead-Free Bilayer
UM-5R	EZ Release Surgery Front Apron - Medium/0.5mm Regular Lead
UM-5L	EZ Release Surgery Front Apron - Medium/0.5mm Lightweight Lead
UM-5N	EZ Release Surgery Front Apron - Medium/0.5mm Lead-Free Bilayer
UL-5R	EZ Release Surgery Front Apron - Large/0.5mm Regular Lead
UL-5L	EZ Release Surgery Front Apron - Large/0.5mm Lightweight Lead
UL-5N	EZ Release Surgery Front Apron - Large/0.5mm Lead-Free Bilayer
UX-5R	EZ Release Surgery Front Apron - X-Large/0.5mm Regular Lead
UX-5L	EZ Release Surgery Front Apron - X-Large/0.5mm Lightweight Lead
UX-5N	EZ Release Surgery Front Apron - X-Large/0.5mm Lead-Free Bilayer
U2-5R	EZ Release Surgery Front Apron - 2XL/0.5mm Regular Lead
U2-5L	EZ Release Surgery Front Apron - 2XL/0.5mm Lightweight Lead
U2-5N	EZ Release Surgery Front Apron - 2XL/0.5mm Lead-Free Bilayer
U3-5R	EZ Release Surgery Front Apron - 3XL/0.5mm Regular Lead
U3-5L	EZ Release Surgery Front Apron - 3XL/0.5mm Lightweight Lead
U3-5N	EZ Release Surgery Front Apron - 3XL/0.5mm Lead-Free Bilayer



PART NUMBER	DESCRIPTION
VP-3R	EZ Full Wrap Vest - Petite/0.35mm Regular Lead
VP-3L	EZ Full Wrap Vest - Petite/0.35mm Lightweight Lead
VP-3N	EZ Full Wrap Vest - Petite/0.35mm Lead-Free Bilayer
VS-3R	EZ Full Wrap Vest - Small/0.35mm Regular Lead
VS-3L	EZ Full Wrap Vest - Small/0.35mm Lightweight Lead
VS-3N	EZ Full Wrap Vest - Small/0.35mm Lead-Free Bilayer
VM-3R	EZ Full Wrap Vest - Medium/0.35mm Regular Lead
VM-3L	EZ Full Wrap Vest - Medium/0.35mm Lightweight Lead
VM-3N	EZ Full Wrap Vest - Medium/0.35mm Lead-Free Bilayer
VL-3R	EZ Full Wrap Vest - Large/0.35mm Regular Lead
VL-3L	EZ Full Wrap Vest - Large/0.35mm Lightweight Lead
VL-3N	EZ Full Wrap Vest - Large/0.35mm Lead-Free Bilayer
VX-3R	EZ Full Wrap Vest - X-Large/0.35mm Regular Lead
VX-3L	EZ Full Wrap Vest - X-Large/0.35mm Lightweight Lead
VX-3N	EZ Full Wrap Vest - X-Large/0.35mm Lead-Free Bilayer
V2-3R	EZ Full Wrap Vest - 2XL/0.35mm Regular Lead
V2-3L	EZ Full Wrap Vest - 2XL/0.35mm Lightweight Lead
V2-3N	EZ Full Wrap Vest - 2XL/0.35mm Lead-Free Bilayer
V3-3R	EZ Full Wrap Vest - 3XL/0.35mm Regular Lead
V3-3L	EZ Full Wrap Vest - 3XL/0.35mm Lightweight Lead
V3-3N	EZ Full Wrap Vest - 3XL/0.35mm Lead-Free Bilayer
VP-5R	EZ Full Wrap Vest - Petite/0.5mm Regular Lead
VP-5L	EZ Full Wrap Vest - Petite/0.5mm Lightweight Lead
VP-5N	EZ Full Wrap Vest - Petite/0.5mm Lead-Free Bilayer
VS-5R	EZ Full Wrap Vest - Small/0.5mm Regular Lead
VS-5L	EZ Full Wrap Vest - Small/0.5mm Lightweight Lead
VS-5N	EZ Full Wrap Vest - Small/0.5mm Lead-Free Bilayer
VM-5R	EZ Full Wrap Vest - Medium/0.5mm Regular Lead
VM-5L	EZ Full Wrap Vest - Medium/0.5mm Lightweight Lead
VM-5N	EZ Full Wrap Vest - Medium/0.5mm Lead-Free Bilayer
VL-5R	EZ Full Wrap Vest - Large/0.5mm Regular Lead
VL-5L	EZ Full Wrap Vest - Large/0.5mm Lightweight Lead
VL-5N	EZ Full Wrap Vest - Large/0.5mm Lead-Free Bilayer
VX-5R	EZ Full Wrap Vest - X-Large/0.5mm Regular Lead
VX-5L	EZ Full Wrap Vest - X-Large/0.5mm Lightweight Lead
VX-5N	EZ Full Wrap Vest - X-Large/0.5mm Lead-Free Bilayer
V2-5R	EZ Full Wrap Vest - 2XL/0.5mm Regular Lead
V2-5L	EZ Full Wrap Vest - 2XL/0.5mm Lightweight Lead
V2-5N	EZ Full Wrap Vest - 2XL/0.5mm Lead-Free Bilayer
V3-5R	EZ Full Wrap Vest - 3XL/0.5mm Regular Lead
V3-5L	EZ Full Wrap Vest - 3XL/0.5mm Lightweight Lead
V3-5N	EZ Full Wrap Vest - 3XL/0.5mm Lead-Free Bilayer
WP-3R	EZ Reverse Full Wrap Vest - Petite/0.35mm Regular Lead
WP-3L	EZ Reverse Full Wrap Vest - Petite/0.35mm Lightweight Lead
WP-3N	EZ Reverse Full Wrap Vest - Petite/0.35mm Lead-Free Bilayer
WS-3R	EZ Reverse Full Wrap Vest - Small/0.35mm Regular Lead
WS-3L	EZ Reverse Full Wrap Vest - Small/0.35mm Lightweight Lead
WS-3N	EZ Reverse Full Wrap Vest - Small/0.35mm Lead-Free Bilayer
WM-3R	EZ Reverse Full Wrap Vest - Medium/0.35mm Regular Lead
WM-3L	EZ Reverse Full Wrap Vest - Medium/0.35mm Lightweight Lead
WM-3N	EZ Reverse Full Wrap Vest - Medium/0.35mm Lead-Free Bilayer
WL-3R	EZ Reverse Full Wrap Vest - Large/0.35mm Regular Lead
WL-3L	EZ Reverse Full Wrap Vest - Large/0.35mm Lightweight Lead
WL-3N	EZ Reverse Full Wrap Vest - Large/0.35mm Lead-Free Bilayer
WX-3R	EZ Reverse Full Wrap Vest - X-Large/0.35mm Regular Lead
WX-3L	EZ Reverse Full Wrap Vest - X-Large/0.35mm Lightweight Lead
WX-3N	EZ Reverse Full Wrap Vest - X-Large/0.35mm Lead-Free Bilayer
W2-3R	EZ Reverse Full Wrap Vest - 2XL/0.35mm Regular Lead
W2-3L	EZ Reverse Full Wrap Vest - 2XL/0.35mm Lightweight Lead
W2-3N	EZ Reverse Full Wrap Vest - 2XL/0.35mm Lead-Free Bilayer
W3-3R	EZ Reverse Full Wrap Vest - 3XL/0.35mm Regular Lead
W3-3L	EZ Reverse Full Wrap Vest - 3XL/0.35mm Lightweight Lead
W3-3N	EZ Reverse Full Wrap Vest - 3XL/0.35mm Lead-Free Bilayer
WP-5R	EZ Reverse Full Wrap Vest - Petite/0.5mm Regular Lead
WP-5L	EZ Reverse Full Wrap Vest - Petite/0.5mm Lightweight Lead
WP-5N	EZ Reverse Full Wrap Vest - Petite/0.5mm Lead-Free Bilayer
WS-5R	EZ Reverse Full Wrap Vest - Small/0.5mm Regular Lead
WS-5L	EZ Reverse Full Wrap Vest - Small/0.5mm Lightweight Lead
WS-5N	EZ Reverse Full Wrap Vest - Small/0.5mm Lead-Free Bilayer
WM-5R	EZ Reverse Full Wrap Vest - Medium/0.5mm Regular Lead
WM-5L	EZ Reverse Full Wrap Vest - Medium/0.5mm Lightweight Lead
WM-5N	EZ Reverse Full Wrap Vest - Medium/0.5mm Lead-Free Bilayer
WL-5R	EZ Reverse Full Wrap Vest - Large/0.5mm Regular Lead
WL-5L	EZ Reverse Full Wrap Vest - Large/0.5mm Lightweight Lead
WL-5N	EZ Reverse Full Wrap Vest - Large/0.5mm Lead-Free Bilayer
WX-5R	EZ Reverse Full Wrap Vest - X-Large/0.5mm Regular Lead
WX-5L	EZ Reverse Full Wrap Vest - X-Large/0.5mm Lightweight Lead
WX-5N	EZ Reverse Full Wrap Vest - X-Large/0.5mm Lead-Free Bilayer
W2-5R	EZ Reverse Full Wrap Vest - 2XL/0.5mm Regular Lead
W2-5L	EZ Reverse Full Wrap Vest - 2XL/0.5mm Lightweight Lead
W2-5N	EZ Reverse Full Wrap Vest - 2XL/0.5mm Lead-Free Bilayer
W3-5R	EZ Reverse Full Wrap Vest - 3XL/0.5mm Regular Lead
W3-5L	EZ Reverse Full Wrap Vest - 3XL/0.5mm Lightweight Lead
W3-5N	EZ Reverse Full Wrap Vest - 3XL/0.5mm Lead-Free Bilayer
XP-3R	EZ Full Wrap Contour Vest - Petite/0.35mm Regular Lead
XP-3L	EZ Full Wrap Contour Vest - Petite/0.35mm Lightweight Lead
XP-3N	EZ Full Wrap Contour Vest - Petite/0.35mm Lead-Free Bilayer
XS-3R	EZ Full Wrap Contour Vest - Small/0.35mm Regular Lead
XS-3L	EZ Full Wrap Contour Vest - Small/0.35mm Lightweight Lead
XS-3N	EZ Full Wrap Contour Vest - Small/0.35mm Lead-Free Bilayer
XM-3R	EZ Full Wrap Contour Vest - Medium/0.35mm Regular Lead
XM-3L	EZ Full Wrap Contour Vest - Medium/0.35mm Lightweight Lead
XM-3N	EZ Full Wrap Contour Vest - Medium/0.35mm Lead-Free Bilayer
XL-3R	EZ Full Wrap Contour Vest - Large/0.35mm Regular Lead



PART NUMBER	DESCRIPTION
XL-3L	EZ Full Wrap Contour Vest - Large/0.35mm Lightweight Lead
XL-3N	EZ Full Wrap Contour Vest - Large/0.35mm Lead-Free Bilayer
XX-3R	EZ Full Wrap Contour Vest - X-Large/0.35mm Regular Lead
XX-3L	EZ Full Wrap Contour Vest - X-Large/0.35mm Lightweight Lead
XX-3N	EZ Full Wrap Contour Vest - X-Large/0.35mm Lead-Free Bilayer
X2-3R	EZ Full Wrap Contour Vest - 2XL/0.35mm Regular Lead
X2-3L	EZ Full Wrap Contour Vest - 2XL/0.35mm Lightweight Lead
X2-3N	EZ Full Wrap Contour Vest - 2XL/0.35mm Lead-Free Bilayer
X3-3R	EZ Full Wrap Contour Vest - 3XL/0.35mm Regular Lead
X3-3L	EZ Full Wrap Contour Vest - 3XL/0.35mm Lightweight Lead
X3-3N	EZ Full Wrap Contour Vest - 3XL/0.35mm Lead-Free Bilayer
XP-5R	EZ Full Wrap Contour Vest - Petite/0.5mm Regular Lead
XP-5L	EZ Full Wrap Contour Vest - Petite/0.5mm Lightweight Lead
XP-5N	EZ Full Wrap Contour Vest - Petite/0.5mm Lead-Free Bilayer
X5-5R	EZ Full Wrap Contour Vest - Small/0.5mm Regular Lead
X5-5L	EZ Full Wrap Contour Vest - Small/0.5mm Lightweight Lead
X5-5N	EZ Full Wrap Contour Vest - Small/0.5mm Lead-Free Bilayer
XM-5R	EZ Full Wrap Contour Vest - Medium/0.5mm Regular Lead
XM-5L	EZ Full Wrap Contour Vest - Medium/0.5mm Lightweight Lead
XM-5N	EZ Full Wrap Contour Vest - Medium/0.5mm Lead-Free Bilayer
XL-5R	EZ Full Wrap Contour Vest - Large/0.5mm Regular Lead
XL-5L	EZ Full Wrap Contour Vest - Large/0.5mm Lightweight Lead
XL-5N	EZ Full Wrap Contour Vest - Large/0.5mm Lead-Free Bilayer
XX-5R	EZ Full Wrap Contour Vest - X-Large/0.5mm Regular Lead
XX-5L	EZ Full Wrap Contour Vest - X-Large/0.5mm Lightweight Lead
XX-5N	EZ Full Wrap Contour Vest - X-Large/0.5mm Lead-Free Bilayer
X2-5R	EZ Full Wrap Contour Vest - 2XL/0.5mm Regular Lead
X2-5L	EZ Full Wrap Contour Vest - 2XL/0.5mm Lightweight Lead
X2-5N	EZ Full Wrap Contour Vest - 2XL/0.5mm Lead-Free Bilayer
X3-5R	EZ Full Wrap Contour Vest - 3XL/0.5mm Regular Lead
X3-5L	EZ Full Wrap Contour Vest - 3XL/0.5mm Lightweight Lead
X3-5N	EZ Full Wrap Contour Vest - 3XL/0.5mm Lead-Free Bilayer

MOBILE BARRIERS

TD1-18-11	Leaded Table Drape - Single 18" x 12" Panel (L x W)/0.5mm Reg. Lead/11-Royal Blue
TD1-18-33	Leaded Table Drape - Single 18" x 12" Panel (L x W)/0.5mm Reg. Lead/33-Black
TD1-24-11	Leaded Table Drape - Single 24" x 12" Panel (L x W)/0.5mm Reg. Lead/11-Royal Blue
TD1-24-33	Leaded Table Drape - Single 24" x 12" Panel (L x W)/0.5mm Reg. Lead/33-Black
TD1-30-11	Leaded Table Drape - Single 30" x 12" Panel (L x W)/0.5mm Reg. Lead/11-Royal Blue
TD1-30-33	Leaded Table Drape - Single 30" x 12" Panel (L x W)/0.5mm Reg. Lead/33-Black
TD1-36-11	Leaded Table Drape - Single 36" x 12" Panel (L x W)/0.5mm Reg. Lead/11-Royal Blue
TD1-36-33	Leaded Table Drape - Single 36" x 12" Panel (L x W)/0.5mm Reg. Lead/33-Black
TDHS	Table Drape Hanging Straps - Set of 2 [8" Hook & Loop Straps]
TL-1-24	Table Drape Adhesive Table Liner - Single 24" x 1" Strip (L x W)/Black
TL-1-48	Table Drape Adhesive Table Liner - Single 48" x 1" Strip (L x W)/Black
LPS-H3636	Premium H-Base Mobile Shield - 36 x 36/0.5mm Reg. Lead/5-Star Base
LPS-H4848	Premium H-Base Mobile Shield - 48 x 48/0.5mm Reg. Lead/5-Star Base
LPS-S2424	Economy Star-Base Mobile Shield - 24 x 24/0.5mm Reg. Lead/5-Star Base
LPS-S2436	Economy Star-Base Mobile Shield - 24 x 36/0.5mm Reg. Lead/5-Star Base
LPS-S2448	Economy Star-Base Mobile Shield - 24 x 48/0.5mm Reg. Lead/5-Star Base
LPSG-S2424	Economy Star-Base Mobile Shield - 24 x 24/0.5mm Lead-Free Bilayer/5-Star Base
LPSG-S2436	Economy Star-Base Mobile Shield - 24 x 36/0.5mm Lead-Free Bilayer/5-Star Base
LPSG-S2448	Economy Star-Base Mobile Shield - 24 x 48/0.5mm Lead-Free Bilayer/5-Star Base
LPS-T2424S	Standard T-Base Mobile Shield - 24 x 24/0.5mm Reg. Lead/T-Base
LPS-T2430S	Standard T-Base Mobile Shield - 24 x 30/0.5mm Reg. Lead/T-Base
LPS-T2436S	Standard T-Base Mobile Shield - 24 x 36/0.5mm Reg. Lead/T-Base
LPS-T2448S	Standard T-Base Mobile Shield - 24 x 48/0.5mm Reg. Lead/T-Base
LPS-T3030S	Standard T-Base Mobile Shield - 30 x 30/0.5mm Reg. Lead/T-Base
LPS-T3036S	Standard T-Base Mobile Shield - 30 x 36/0.5mm Reg. Lead/T-Base
LPS-T3042S	Standard T-Base Mobile Shield - 30 x 42/0.5mm Reg. Lead/T-Base
LB-2430	Standard Leaded Glass Mobile X-Ray Barriers - 30 x 24 Window/33 x 75
LB-3048	Standard Leaded Glass Mobile X-Ray Barriers - 30 x 48 Window/33 x 75
LB-3060	Standard Leaded Glass Mobile X-Ray Barriers - 30 x 60 Window/33 x 75
LB-3036	Standard Leaded Glass Mobile X-Ray Barriers - 36 x 30 Window/33 x 75
LB-3648	Specialty Leaded Glass Mobile X-Ray Barriers - 48 x 36 Window/52.5 x 75
LB-3672	Specialty Leaded Glass Mobile X-Ray Barriers - 72 x 36 Window/75.5 x 75
LB-7429	Adjustable Height Leaded Glass Mobile X-Ray Barriers - 24 x 24 Window/31 x 41 Opaque Panel/31 x 70
LB-1012-2472	Compact Window Leaded Glass Mobile X-Ray Barriers - 12 x 10 Window/24 x 72
LB-1012-3072	Compact Window Leaded Glass Mobile X-Ray Barriers - 12 x 10 Window/30 x 72
LB-1012-3672	Compact Window Leaded Glass Mobile X-Ray Barriers - 12 x 10 Window/36 x 72

PANEL POSITIONERS

MCH-33B	Mobile Tilt & Rotate CR/DR Panel Holder (Vertical Clamp)
MCH-33C	Mobile Tilt & Rotate CR/DR Panel Holder (Horizontal Clamp)
MCH-37B	Mobile Full Motion CR/DR Panel Holder (Vertical Clamp)
MCH-37C	Mobile Full Motion CR/DR Panel Holder (Horizontal Clamp)
MCH-SKW	
MCH-SKC	

PART NUMBER
DESCRIPTION

PATIENT POSITIONERS

31220	Dual Platform Bariatric Step Stool with Handrail
FIL-12	Patient Foot Immobilizer
FSA3001-01	MRI Single Platform Step Stool with Handrail
FSM1726-01	MRI Dual Platform Step Stool With Handrail
GP0132	Nylon Covered MRI Rectangle Positioner Set (Set of 2) [14" x 3" x 1"]
GP0152	Nylon Covered MRI Rectangle Positioner Set (Set of 2) [5" x 3" x 1"]
GP0162	Nylon Covered MRI Wedge Positioner Set (Set of 2) [10" x 10" x 3"]
GP0172	Nylon Covered MRI Wedge Positioner Set (Set of 2) [14" x 4" x 1.5"]
GP0182	Nylon Covered MRI Rectangle Positioner Set (Set of 2) [4" x 3" x 2"]
GP0192	Nylon Covered MRI Wedge Positioner Set (Set of 2) [14" x 4" x 1.5"]
GP0202	Nylon Covered MRI Semi-Round Neck Roll Positioner [7" x 3" x 2.3"]
GE1211	Nylon Covered MRI Wedge Positioner [28.2" x 16" x 8"]
GP0102	Nylon Covered MRI Positioner Bundle
LGS	Adjustable Leg Support - Bariatric Base (15" x 18") [Previously sold as LGS-B11]
LGS-S	Adjustable Leg Support - Standard Base (9" x 12") [Previously sold as LGS-09]
Q15645	Thin Elastic Extremity Straps - 0.625 (5/8)" x 29" [Set of 2]
Q15647	Standard Elastic Extremity Straps - 1" x 29" [Set of 2]
Q15648	Extremity Strap Table Liner - 15' (5 Yards) [Black]
Q15645-B	Thin Elastic Extremity Strap Bundle - 0.625 (5/8)" x 29" [Set of 2] + TL-1 [15" Black Loop]
Q15647-B	Standard Elastic Extremity Strap Bundle - 1" x 29" [Set of 2] + TL-1 [15" Black Loop]
RHI-AB	Patient Head Immobilizer (Table-Top design with Coated Sponge cushions) [Coated Sponge - 6 x 6 x 2]
RIS-60-BLK	Heavy-Gauge Vinyl Immobilizer Strap (60" x 10")
RIS-72-BLK	Heavy-Gauge Vinyl Immobilizer Strap (72" x 10")
RIS-84-BLK	Heavy-Gauge Vinyl Immobilizer Strap (84" x 10")
RIS-96-BLK	Heavy-Gauge Vinyl Immobilizer Strap (96" x 10")
RLC-36	Lateral Chest Image Support Positioner (36")
RLC-48	Lateral Chest Image Support Positioner (48")
SB-01R-BLK-AC	Heavy-Gauge Vinyl Rectangular Sandbag; 11b (4 x 5) - AC Joint Handle [Black]
SB-01R-BLK-ST	Heavy-Gauge Vinyl Rectangular Sandbag; 11b (4 x 5) - Standard Handle [Black]
SB-01R-BLU-AC	Heavy-Gauge Vinyl Rectangular Sandbag; 11b (4 x 5) - AC Joint Handle [Blue]
SB-01R-BLU-ST	Heavy-Gauge Vinyl Rectangular Sandbag; 11b (4 x 5) - Standard Handle [Blue]
SB-02R-BLK-AC	Heavy-Gauge Vinyl Rectangular Sandbag; 21b (4 x 9) - AC Joint Handle [Black]
SB-02R-BLK-ST	Heavy-Gauge Vinyl Rectangular Sandbag; 21b (4 x 9) - Standard Handle [Black]
SB-02R-BLU-AC	Heavy-Gauge Vinyl Rectangular Sandbag; 21b (4 x 9) - AC Joint Handle [Blue]
SB-02R-BLU-ST	Heavy-Gauge Vinyl Rectangular Sandbag; 21b (4 x 9) - Standard Handle [Blue]
SB-03R-BLK-AC	Heavy-Gauge Vinyl Rectangular Sandbag; 31b (5 x 9) - AC Joint Handle [Black]
SB-03R-BLK-ST	Heavy-Gauge Vinyl Rectangular Sandbag; 31b (5 x 9) - Standard Handle [Black]
SB-03R-BLU-AC	Heavy-Gauge Vinyl Rectangular Sandbag; 31b (5 x 9) - AC Joint Handle [Blue]
SB-03R-BLU-ST	Heavy-Gauge Vinyl Rectangular Sandbag; 31b (5 x 9) - Standard Handle [Blue]
SB-05R-BLK-AC	Heavy-Gauge Vinyl Rectangular Sandbag; 51b (6 x 12) - AC Joint Handle [Black]
SB-05R-BLK-ST	Heavy-Gauge Vinyl Rectangular Sandbag; 51b (6 x 12) - Standard Handle [Black]
SB-05R-BLU-AC	Heavy-Gauge Vinyl Rectangular Sandbag; 51b (6 x 12) - AC Joint Handle [Blue]
SB-05R-BLU-ST	Heavy-Gauge Vinyl Rectangular Sandbag; 51b (6 x 12) - Standard Handle [Blue]
SB-05S-BLK-AC	Heavy-Gauge Vinyl Square Sandbag; 51b (9 x 9) - AC Joint Handle [Black]
SB-05S-BLK-ST	Heavy-Gauge Vinyl Square Sandbag; 51b (9 x 9) - Standard Handle [Black]
SB-05S-BLU-AC	Heavy-Gauge Vinyl Square Sandbag; 51b (9 x 9) - AC Joint Handle [Blue]
SB-05S-BLU-ST	Heavy-Gauge Vinyl Square Sandbag; 51b (9 x 9) - Standard Handle [Blue]
SB-07R-BLK-AC	Heavy-Gauge Vinyl Rectangular Sandbag; 71b (6 x 14) - AC Joint Handle [Black]
SB-07R-BLK-ST	Heavy-Gauge Vinyl Rectangular Sandbag; 71b (6 x 14) - Standard Handle [Black]
SB-07R-BLU-AC	Heavy-Gauge Vinyl Rectangular Sandbag; 71b (6 x 14) - AC Joint Handle [Blue]
SB-07R-BLU-ST	Heavy-Gauge Vinyl Rectangular Sandbag; 71b (6 x 14) - Standard Handle [Blue]
SB-07S-BLK-AC	Heavy-Gauge Vinyl Square Sandbag; 71b (10 x 10) - AC Joint Handle [Black]
SB-07S-BLK-ST	Heavy-Gauge Vinyl Square Sandbag; 71b (10 x 10) - Standard Handle [Black]
SB-07S-BLU-AC	Heavy-Gauge Vinyl Square Sandbag; 71b (10 x 10) - AC Joint Handle [Blue]
SB-07S-BLU-ST	Heavy-Gauge Vinyl Square Sandbag; 71b (10 x 10) - Standard Handle [Blue]
SB-10R-BLK-AC	Heavy-Gauge Vinyl Rectangular Sandbag; 101b (7 x 16) - AC Joint Handle [Black]
SB-10R-BLK-ST	Heavy-Gauge Vinyl Rectangular Sandbag; 101b (7 x 16) - Standard Handle [Black]
SB-10R-BLU-AC	Heavy-Gauge Vinyl Rectangular Sandbag; 101b (7 x 16) - AC Joint Handle [Blue]
SB-10R-BLU-ST	Heavy-Gauge Vinyl Rectangular Sandbag; 101b (7 x 16) - Standard Handle [Blue]
SB-10S-BLK-AC	Heavy-Gauge Vinyl Square Sandbag; 101b (11 x 11) - AC Joint Handle [Black]
SB-10S-BLK-ST	Heavy-Gauge Vinyl Square Sandbag; 101b (11 x 11) - Standard Handle [Black]
SB-10S-BLU-AC	Heavy-Gauge Vinyl Square Sandbag; 101b (11 x 11) - AC Joint Handle [Blue]
SB-10S-BLU-ST	Heavy-Gauge Vinyl Square Sandbag; 101b (11 x 11) - Standard Handle [Blue]
SB-12R-BLK-AC	Heavy-Gauge Vinyl Rectangular Sandbag; 121b (8 x 18) - AC Joint Handle [Black]
SB-12R-BLK-ST	Heavy-Gauge Vinyl Rectangular Sandbag; 121b (8 x 18) - Standard Handle [Black]
SB-12R-BLU-AC	Heavy-Gauge Vinyl Rectangular Sandbag; 121b (8 x 18) - AC Joint Handle [Blue]
SB-12R-BLU-ST	Heavy-Gauge Vinyl Rectangular Sandbag; 121b (8 x 18) - Standard Handle [Blue]
SBG1003-01	MRI Heavy-Gauge Vinyl Square Sandbag; 31b (8 x 8) - Standard Handle [Black]
SBG1005-01	MRI Heavy-Gauge Vinyl Rectangular Sandbag; 51b (5 x 15) - Standard Handle [Black]
SBG1007-01	MRI Heavy-Gauge Vinyl Rectangular Sandbag; 71b (9 x 12) - Standard Handle [Black]
SBG1010-01	MRI Heavy-Gauge Vinyl Rectangular Sandbag; 101b (9 x 14) - Standard Handle [Black]
SBG1012-01	MRI Heavy-Gauge Vinyl Square Sandbag; 12.51b (12 x 12) - Standard Handle [Black]
SBG1013-01	MRI Heavy-Gauge Vinyl Sandbag Bundle - Standard Handle [Black]
SBK-01-BLK-ST	Heavy-Gauge Vinyl Sandbag General Bundle 1 - Standard Handles [Black]
SBK-01-BLU-ST	Heavy-Gauge Vinyl Sandbag General Bundle 1 - Standard Handles [Blue]
SBK-02-BLK-ST	Heavy-Gauge Vinyl Sandbag General Bundle 2 - Standard Handles [Black]
SBK-02-BLU-ST	Heavy-Gauge Vinyl Sandbag General Bundle 2 - Standard Handles [Blue]
SBK-03-BLK-ST	Heavy-Gauge Vinyl Sandbag General Bundle 3 - Standard Handles [Black]
SBK-03-BLU-ST	Heavy-Gauge Vinyl Sandbag General Bundle 3 - Standard Handles [Blue]
SBK-04-BLK-ST	Heavy-Gauge Vinyl Sandbag Pediatric Bundle - Standard Handles [Black]
SBK-04-BLU-ST	Heavy-Gauge Vinyl Sandbag Pediatric Bundle - Standard Handles [Blue]
SBPR-05S-BLK-AC	Heavy-Gauge Vinyl Sandbag Pair; Two 51b (9 x 9) - AC Joint Handles [Black]
SBPR-05S-BLK-ST	Heavy-Gauge Vinyl Sandbag Pair; Two 51b (9 x 9) - Standard Handles [Black]
SBPR-05S-BLU-AC	Heavy-Gauge Vinyl Sandbag Pair; Two 51b (9 x 9) - AC Joint Handles [Blue]
SBPR-05S-BLU-ST	Heavy-Gauge Vinyl Sandbag Pair; Two 51b (9 x 9) - Standard Handles [Blue]
SBPR-10S-BLK-AC	Heavy-Gauge Vinyl Sandbag Pair; Two 101b (11 x 11) - AC Joint Handles [Black]
SBPR-10S-BLK-ST	Heavy-Gauge Vinyl Sandbag Pair; Two 101b (11 x 11) - Standard Handles [Black]
SBPR-10S-BLU-AC	Heavy-Gauge Vinyl Sandbag Pair; Two 101b (11 x 11) - AC Joint Handles [Blue]
SBPR-10S-BLU-ST	Heavy-Gauge Vinyl Sandbag Pair; Two 101b (11 x 11) - Standard Handles [Blue]
SS-01R-BLK-NH	Flexible Vinyl Sandsock; 11b (2 x 8) [Black]

PART NUMBER	DESCRIPTION
SS-01R-TAN-NH	Flexible Vinyl Sandsock: 1lb (2 x 8) [Tan]
SS-03R-BLK-NH	Flexible Vinyl Sandsock: 3lb (4 x 12) [Black]
SS-03R-TAN-NH	Flexible Vinyl Sandsock: 3lb (4 x 12) [Tan]
SS-04R-BLK-NH	Flexible Vinyl Sandsock: 4lb (8 x 10) [Black]
SS-04R-TAN-NH	Flexible Vinyl Sandsock: 4lb (8 x 10) [Tan]
SS-05R-BLK-NH	Flexible Vinyl Sandsock: 5lb (6 x 15) [Black]
SS-05R-TAN-NH	Flexible Vinyl Sandsock: 5lb (6 x 15) [Tan]
SS-07R-BLK-NH	Flexible Vinyl Sandsock: 7lb (6 x 18) [Black]
SS-07R-TAN-NH	Flexible Vinyl Sandsock: 7lb (6 x 18) [Tan]
SS-08R-BLK-NH	Flexible Vinyl Sandsock: 8lb (7 x 22) [Black]
SS-08R-TAN-NH	Flexible Vinyl Sandsock: 8lb (7 x 22) [Tan]
SS-10R-BLK-NH	Flexible Vinyl Sandsock: 10lb (6 x 20) [Black]
SS-10R-TAN-NH	Flexible Vinyl Sandsock: 10lb (6 x 20) [Tan]
SS-11R-BLK-NH	Flexible Vinyl Sandsock: 11lb (6 x 28) [Black]
SS-11R-TAN-NH	Flexible Vinyl Sandsock: 11lb (6 x 28) [Tan]
SS-12R-BLK-NH	Flexible Vinyl Sandsock: 12lb (6 x 25) [Black]
SS-12R-TAN-NH	Flexible Vinyl Sandsock: 12lb (6 x 25) [Tan]
SS-15R-BLK-NH	Flexible Vinyl Sandsock: 15lb (6 x 40) [Black]
SS-15R-TAN-NH	Flexible Vinyl Sandsock: 15lb (6 x 40) [Tan]
SSK-01-BLK-NH	Flexible Vinyl Sandsock General Bundle 1 [Black]
SSK-01-TAN-NH	Flexible Vinyl Sandsock General Bundle 1 [Tan]
SSK-02-BLK-NH	Flexible Vinyl Sandsock General Bundle 2 [Black]
SSK-02-TAN-NH	Flexible Vinyl Sandsock General Bundle 2 [Tan]
SSK-03-BLK-NH	Flexible Vinyl Sandsock General Bundle 3 [Black]
SSK-03-TAN-NH	Flexible Vinyl Sandsock General Bundle 3 [Tan]
SSK-04-BLK-NH	Flexible Vinyl Sandsock General Bundle 4 [Black]
SSK-04-TAN-NH	Flexible Vinyl Sandsock General Bundle 4 [Tan]
T-6150	Single Platform Bariatric Step Stool with Handrail
T-50	Standard Single Platform Step Stool with Handrail
VIC429ST	Video Fluoroscopic Imaging Chair (Spruce Green)
VIS-60-BLK	Heavy-Gauge Vinyl Veterinary Immobilizer Strap (60" x 5")
VIS-72-BLK	Heavy-Gauge Vinyl Veterinary Immobilizer Strap (72" x 5")
VIS-84-BLK	Heavy-Gauge Vinyl Veterinary Immobilizer Strap (84" x 5")
VIS-96-BLK	Heavy-Gauge Vinyl Veterinary Immobilizer Strap (96" x 5")
VIT-S	Heavy-Gauge Vinyl Veterinary Immobilizer Trough - Small (10" x 4" x 3")
VIT-M	Heavy-Gauge Vinyl Veterinary Immobilizer Trough - Medium (15" x 7" x 5")
VIT-L	Heavy-Gauge Vinyl Veterinary Immobilizer Trough - Large (24" x 11" x 7")
VIT-X	Heavy-Gauge Vinyl Veterinary Immobilizer Trough - X-Large (36" x 14" x 9")
VIT-B	Heavy-Gauge Vinyl Veterinary Immobilizer Trough - Bundle (1 of each size)
WMP-2S	Three Step Weight Bearing Imaging Platform (Comfort Closed Cell steps)
WMP-2H	Two Step Weight Bearing Imaging Platform (Comfort Closed Cell steps)
WMP-3S	Two Step Weight Bearing Imaging Platform (Reinforced plastic steps)
WMP-3H	Three Step Weight Bearing Imaging Platform (Reinforced plastic steps)
YBBA	Non-Coated 45° Bariatric Spinal Wedge Sponge (Stealth) [27.5" x 10" x 7"]
YB-C-A02	Coated Urgent Care Sponge Bundle (1 each - YCAA, YCAD, YCAK, YCBC, YCDB, YCBE, YCBI, YCBL, YCBN)
YB-C-A04	Coated Clinic Sponge Bundle A (1 each - YCAA, YCAK, YCBB, YCBI)
YB-C-A05	Coated Clinic Sponge Bundle B (1 each - YCAA, YCAK, YCBC, YCBD, YCBE, YCBI, YCBI, YCBL)
YB-C-A06	Coated CT Sponge Bundle A (1 each - YCBB, YCBC, YCBE, YCBF, YCBG, YCBI, YCBI, YCBW)
YB-C-A07	Coated General Sponge Bundle A (1 each - YCAK, YCBC, YCBE, YCBI, YCBL)
YB-C-A08	Coated General Sponge Bundle B (1 each - YCAA, YCAK, YCBC, YCBE, YCBI, YCBI, YCBL)
YB-C-A09	Coated General Sponge Bundle C (1 each - YCAA, YCAM, YCAR, YCAY, YCBL, YCAH)
YB-C-A10	Coated General Sponge Bundle D (1 each - YCAL, YCAN, YCAR, YCBF, YCBI, YCBL)
YB-C-A11	Coated General Sponge Bundle E (1 each - YCAA, YCAK, YCAM, YCBB, YCBG, YCBI, YCBL, YCBN, YCBU)
YB-C-A12	Coated General Sponge Bundle G (1 each - YCAA, YCAK, YCBD, YCBE, YCBI, YCBL)
YB-C-A13	Coated General Sponge Bundle P (1 each - YCAA, YCAK, YCBD, YCBI)
YB-C-A15	Coated General Sponge Bundle 1 (2 each - YCAK; 1 each - YCBD, YCBI, YCBL, YCBT)
YB-C-A16	Coated Orthopedic Sponge Bundle A (1 each - YCAA, YCAM, YCAR, YCBD, YCBL)
YB-C-A17	Coated Orthopedic Sponge Bundle B (1 each - YCAL, YCAN, YCAR, YCBC, YCBG, YCBI, YCBL)
YB-C-A18	Coated Orthopedic Sponge Bundle D (1 each - YCAA, YCAR, YCBD, YCBI, YCBL)
YB-C-A19	Coated Pediatric Sponge Bundle (1 each - YCAC, YCAE, YCAK, YCAN, YCAQ, YCAX)
YB-C-A20	Coated Wedge Sponge Bundle A (1 each - YCBC, YCBF, YCBG, YCBI)
YB-C-A21	Coated Wedge Sponge Bundle B (1 each - YCBD, YCBE, YCBF, YCBG)
YB-C-A22	Coated Bariatric Sponge Bundle (1 each - YCAT, YCBA, YCBM, YCBP)
YB-C-A23	Coated Rectangle Sponge Bundle (3 each - YCBQ, YCBR, YCBS, YCBT)
YB-C-A24	Coated Scanning Support Sponge Bundle A (10 each - YCBT)
YB-C-A25	Coated Ultrasound Sponge Bundle (1 each - YCAY, YCEE, YCUZ)
YB-C-A26	Coated Ultrasound Breast or Paracentesis Sponge Bundle (1 each - YCBG, YCFD, YCBU)
YB-F-A02	Non-Coated Urgent Care Sponge Bundle (1 each - YFAA, YFAD, YFAK, YFBC, YFBD, YFBE, YFBJ, YFBL, YFBN)
YB-F-A04	Non-Coated Clinic Bundle A (1 each - YFBB, YFAA, YFAK, YFBI)
YB-F-A05	Non-Coated Clinic Sponge Bundle B (1 each - YFAA, YFAK, YFBC, YFBE, YFBI, YFBJ, YFBL, YFBD)
YB-F-A06	Non-Coated CT Positioning Sponge Bundle (1 each - YFBB, YFBC, YFBE, YFBF, YFBG, YFBI, YFBJ, YFBW)
YB-F-A07	Non-Coated General Sponge Bundle A (1 each - YFAK, YFBC, YFBE, YFBI, YFBL)
YB-F-A08	Non-Coated General Sponge Bundle B (1 each - YFAA, YFAK, YFBC, YFBE, YFBI, YFBJ, YFBL)
YB-F-A10	Non-Coated General Sponge Bundle D (1 each - YFAL, YFAN, YFAR, YFBB, YFBJ, YFBL)
YB-F-A12	Non-Coated General Sponge Bundle G (1 each - YFAA, YFAK, YFBD, YFBE, YFBI, YFBL)
YB-F-A13	Non-Coated General Sponge Bundle P (1 each - YFAA, YFAK, YFBD, YFBI)
YB-F-A16	Non-Coated Ortho Sponge Bundle A (1 each - YFAA, YFAM, YFAR, YFBD, YFBL)
YB-F-A19	Non-Coated Pediatric Sponge Bundle (1 each - YFAC, YFAE, YFAK, YFAN, YFAQ, YFAX, YFBT)
YB-F-A20	Non-Coated Wedge Sponge Bundle A (1 each - YFBC, YFBE, YFBG, YFBI)
YB-F-A21	Non-Coated Wedge Sponge Bundle B (1 each - YFBD, YFBE, YFBF, YFBG)
YB-V-A01	Vinyl Covered Veterinary Sponge Bundle (1 each - YVBI, YVBT, YVBR, YVAM, YVFO)
YB-X-A01	Closed Cell Veterinary Sponge Bundle (1 each - YXBI, YXBT, YXBR, YXAM, YXBD)
YB-X-A02	Closed Cell Urgent Care Sponge Bundle (1 each - YXAA, YXAD, YXAK, YXBC, YXBD, YXBE, YXBJ, YXBL, YXBN)
YB-X-A03	Closed Cell Alternate Urgent Care Sponge Bundle (1 each - YXAA, YXAD, YXAK, YXBC, YXBD, YXBE, YXBI, YXBL, YXBN)
YB-X-A04	Closed Cell Clinic Sponge Bundle A (1 each - YXAA, YXAK, YXBB, YXBI)
YB-X-A05	Closed Cell Clinic Sponge Bundle B (1 each - YXAA, YXAK, YXBC, YXBD, YXBE, YXBI, YXBJ, YXBL)
YB-X-A14	Closed Cell General Sponge Bundle 1 (1 each - YXAA, YXAK, YXBD, YXBI, YXBN, YXBV, YXMB)
YB-X-A07	Closed Cell General Sponge Bundle A (1 each - YXAA, YXBC, YXBE, YXBI, YXBL)
YB-X-A08	Closed Cell General Sponge Bundle B (1 each - YXAA, YXAK, YXBC, YXBE, YXBI, YXBJ, YXBL)
YB-X-A13	Closed Cell General Sponge Bundle P (1 each - YXAA, YXAK, YXBD, YXBI)
YB-X-A27	Closed Cell Veterinary Surgery Sponge Bundle (1 each - YXBI, YXBT, YXBR, YXAM, YXBD, YXBC)
YB-X-A28	Closed Cell Veterinary Immobilizer Trough Bundle (1 each - YXCA, YXCB, YXCC, YXCD)
YCAA	Coated Adult Oblique Finger Block Sponge (Stealth) [10.5" x 6" x 3"]
YCAB	Coated Bilateral Adult Oblique Finger Block Sponge (Stealth) [12.5" x 10.5" x 3"]



PART NUMBER

DESCRIPTION

YCAC	Coated Bilateral Pediatric Oblique Finger Block Sponge (Stealth) [7.75" x 7.5" x 2"]
YCAD	Coated Adult Lateral Finger Block Sponge (Stealth) [13" x 8" x 3"]
YCAE	Coated Pediatric Lateral Finger Block Sponge (Stealth) [7" x 4" x 1.75"]
YCAG	Coated Bilateral Leg Immobilizer Sponge (Stealth) [21" x 20" x 6"]
YCAH	Coated Knee Arthrogram Block Sponge (Stealth) [19" x 14.5" x 8"]
YCAJ	Coated 26° Knee Wedge Support Sponge (Stealth) [21" x 19" x 8"]
YCAK	Coated Circular Head Block Sponge (Stealth) [Diameter: 7" (Top) x 9" (Base) x 1.5"]
YCAL	Coated Head & Neck Support Sponge (Stealth) [14" x 16" x 6.5"]
YCAM	Coated AP/PA Adult Head Holder Sponge (Stealth) [15" x 14" x 6.75"]
YCAN	Coated AP/PA Child Head Holder Sponge (Stealth) [11" x 9.75" x 5"]
YCAP	Coated Adult Head Immobilizer Sponge (Stealth) [15.25" x 9" x 7"]
YCAQ	Coated Child Head Immobilizer Sponge (Stealth) [11.5" x 6.75" x 5.25"]
YCAR	Coated Cervical Headrest Sponge (Stealth) [16" x 7.5" x 4.5"]
YCAS	Coated Knee Arthroplasty Stress Assembly Sponge Set (Non-Stealth)
YCAT	Coated Bariatric Torso Sponge (Stealth) [16.5" x 18.5" x 7"]
YCAW	Coated Adult Myelogram Block Sponge (Non-Stealth) [22" x 10" x 14"]
YCA X	Coated Child Myelogram Block Sponge (Non-Stealth) [14" x 8" x 10"]
YCA Y	Coated Specialty Angular Bolster Sponge (Stealth) [22.5" x 14" x 7.25"]
YCBA	Coated 45° Bariatric Spinal Wedge Sponge (Stealth) [27.5" x 10" x 7"]
YCB B	Coated 45° Spinal Wedge Sponge (Stealth) [20.25" x 10" x 7"]
YCB C	Coated 45° Spinal Body Wedge Sponge (Stealth) [13.5" x 10" x 7"]
YCB D	Coated 45° Spinal Body Wedge Sponge (Stealth) [27.25" x 10" x 7"]
YCB E	Coated 34° Wedge Sponge Set (Stealth) [9.75" x 5.5" x 3"]
YCB F	Coated 27° Wedge Sponge (Stealth) [15.5" x 12.75" x 6"]
YCB G	Coated 21° Wedge Sponge (Stealth) [14.25" x 12.25" x 4.5"]
YCB H	Coated 16° Wedge Sponge Set (Stealth) [11" x 8.5" x 3.5"]
YCB I	Coated 15° Wedge Sponge Set (Stealth) [10" x 12.5" x 3"]
YCB J	Coated 12° Wedge Sponge Set (Stealth) [9.25" x 10.5" x 2.25"]
YCB L	Coated Rectangle Sponge (Stealth) [12.5" x 10.25" x 3"]
YCB M	Coated Bariatric Rectangle Sponge (Stealth) [14.5" x 10.5" x 3"]
YCB N	Coated Rectangle Sponge (Stealth) [20.5" x 16.25" x 3"]
YCB O	Coated Square Sponge (Stealth) [13.5" x 13.5" x 4"]
YCB P	Coated Bariatric Decubitus Rectangle Sponge (Stealth) [27.5" x 21.5" x 4"]
YCB Q	Coated Rectangle Sponge (Non-Stealth) [6" x 4" x 0.5"]
YCB R	Coated Rectangle Sponge (Non-Stealth) [6" x 4" x 1"]
YCB S	Coated Rectangle Sponge (Non-Stealth) [6" x 4" x 1.5"]
YCB T	Coated Rectangle Sponge (Non-Stealth) [6" x 4" x 2"]
YCB U	Coated 30°-60°-90° Multiangle Wedge (Stealth) [29.5" x 10" x 6"]
YCB V	Coated Square Sponge (Non-Stealth) [6" x 6" x 2"]
YCB W	Coated CT Headrest Sponge (Non-Stealth) [12.5" x 11" x 10"]
YCB Y	Coated Rectangle Sponge (Stealth) [27.5" x 21.5" x 4"]
YCCA	Coated Small Extremity Sponge (Stealth) [12.5" x 7" x 3"]
YCC B	Coated Medium Extremity Sponge (Stealth) [19.75" x 11.5" x 5"]
YCC C	Coated Large Extremity Sponge (Stealth) [30.5" x 11" x 7"]
YCC D	Coated Extra Large Extremity Sponge (Stealth) [44.5" x 14" x 9"]
YCC G	Coated 45° Bariatric Body Wedge Sponge (Non-Stealth) [30" x 9" x 9"]
YCD A	Coated 45° Cardiac Wedge Sponge (Non-Stealth) [28" x 19" x 14"]
YCD B	Coated 30° Cardiac Wedge (Non-Stealth) [27" x 28" x 16"]
YCE A	Coated 45° Spinal Wedge Sponge (Stealth) [33" x 13.75" x 9.5"]
YCE B	Coated 45° Wedge Sponge (Stealth) [30" x 10" x 7.5"]
YCE E	Coated 45° XL Echocardiography Wedge Sponge (Stealth) [38.25" x 13" x 9"]
YCE G	Coated 65° Wedge Sponge (Non-Stealth) [25" x 16" x 8.25"]
YCE M	Coated Rectangle Sponge (Non-Stealth) [24" x 15" x 2.5"]
YCE P	Coated Bariatric Endo-Ultrasound Wedge Sponge (Non-Stealth) [16" x 16" x 4.5"]
YCE Q	Coated Perineal Endovaginal/Transvaginal Ultrasound Wedge Sponge (Non-Stealth) [20" x 20" x 3"]
YCE T	Coated Occipital Head Support Sponge (Non-Stealth) [13" x 12.75" x 4.5 Cradle - 3"]
YCE U	Coated 30°-60°-90° Multiangle Bariatric Wedge Sponge (Non-Stealth) [29.5" x 10" x 6"]
YCE V	Coated CT/PET Head Holder Sponge (Non-Stealth) [13.5" x 14" x 6.75"]
YCE W	Coated Philips CT Headrest Sponge (Non-Stealth) [12" x 12.5" x 6.5"]
YCE Z	Coated Phlebotomy Wedge (Non-Stealth) [19.5" x 5.5" x 5.5"]
YCF D	Coated 45° Spinal Body Wedge Sponge (Non-Stealth) [21" x 7" x 7"]
YCF L	Coated Left Lateral Finger Sponge (Non-Stealth) [5-6.5" x 7.5" x 3"]
YCF R	Coated Right Lateral Finger Sponge (Non-Stealth) [5-6.5" x 7.5" x 3"]
YCF Q	Coated Decubitus Block with Plate Holder (Non-Stealth) [Lower: 36" x 16" x 4" Back: 36" x 10" x 11" Channel: 36" x 0.5" x 3"]
YCG G	Coated Rectangle Sponge (Non-Stealth) [18" x 8" x 1.5"]
YCM G	Coated Contoured Torso Sponge (Non-Stealth) [18.5" x 17" x 5"]
YCU Z	Coated Endo-Ultrasound Wedge Sponge (Non-Stealth) [20" x 20" x 6"]
YFA A	Non-Coated Adult Oblique Finger Block Sponge (Stealth) [5-6.5" x 7.5" x 3"]
YFA B	Non-Coated Bilateral Adult Oblique Finger Block Sponge (Stealth) [12.5" x 10.5" x 3"]
YFA C	Non-Coated Adult Lateral Finger Block Sponge (Stealth) [7.75" x 7.5" x 2"]
YFA D	Non-Coated Adult Lateral Finger Block Sponge (Stealth) [13" x 8" x 3"]
YFA E	Non-Coated Pediatric Lateral Finger Block Sponge (Stealth) [7" x 4" x 1.75"]
YFA K	Non-Coated Circular Head Block (Stealth) [Diameter: 7" (Top) x 9" (Base) x 3"]
YFA L	Non-Coated Head & Neck Support Sponge (Stealth) [16" x 14.5" x 6.5"]
YFA M	Non-Coated AP/PA Adult Head Holder Sponge (Stealth) [15" x 14" x 6.75"]
YFA N	Non-Coated AP/PA Child Head Holder Sponge (Stealth) [11" x 9.75" x 5"]
YFA Q	Non-Coated Child Head Immobilizer Sponge (Stealth) [11.5" x 6.75" x 5.25"]
YFA R	Non-Coated Cervical Head Rest Sponge (Stealth) [16" x 7.5" x 4.5"]
YFA W	Non-Coated Adult Myelogram Block Sponge (Non-Stealth) [22" x 10" x 14"]
YFA X	Non-Coated Child Myelogram Block Sponge (Non-Stealth) [14" x 8" x 10"]
YFA Y	Non-Coated Specialty Angular Bolster Sponge (Non-Stealth) [22.5" x 14" x 7.25"]
YFBB	Non-Coated 45° Spinal Wedge Sponge (Stealth) [20.25" x 10" x 7"]
YFBC	Non-Coated 45° Spinal Body Wedge Sponge (Stealth) [13.5" x 10" x 7"]
YFBD	Non-Coated 45° Spinal Body Wedge Sponge (Stealth) [27.25" x 10" x 7"]
YFBE	Non-Coated 34° Wedge Sponge Set (Stealth) [9.75" x 5.5" x 3"]
YFBF	Non-Coated 27° Wedge Sponge (Stealth) [15.5" x 12.75" x 6"]
YFBG	Non-Coated 21° Wedge Sponge (Stealth) [14.25" x 12.25" x 4.5"]
YFBH	Non-Coated 16° Wedge Sponge Set (Stealth) [11" x 8.5" x 3.5"]
YFBI	Non-Coated 15° Wedge Sponge Set (Stealth) [10" x 12.5" x 3"]
YFBJ	Non-Coated 12° Wedge Sponge Set (Stealth) [9.25" x 10.5" x 2.25"]
YFBL	Non-Coated Rectangle Sponge (Stealth) [12.5" x 10.25" x 3"]
YFBN	Non-Coated Rectangle Sponge (Stealth) [20.5" x 16.25" x 3"]
YFBO	Non-Coated Square Sponge (Stealth) [13.5" x 13.5" x 4"]
YFBR	Non-Coated Rectangle Sponge (Non-Stealth) [6" x 4" x 1"]

PART NUMBER	DESCRIPTION
YFBT	Non-Coated Rectangle Sponge (Non-Stealth) [6" x 4" x 2"]
YFBU	Non-Coated 30°-60°-90° Multiangle Wedge (Stealth) [29.5" x 10" x 6"]
YFBW	Non-Coated CT Headrest Sponge (Non-Stealth) [12.5" x 11" x 10"]
YFBY	Non-Coated Rectangle Sponge (Stealth) [27.5" x 21.5" x 4"]
YFCA	Non-Coated Small Extremity Sponge (Stealth) [12.5" x 7" x 3"]
YFCB	Non-Coated Medium Extremity Sponge (Stealth) [19.75" x 11.5" x 5"]
YFCC	Non-Coated Large Extremity Sponge (Stealth) [24" x 11" x 7"]
YFCD	Non-Coated Extra Large Extremity Sponge (Stealth) [36" x 14" x 9"]
YFDB	Non-Coated 30° Cardiac Wedge Sponge (Non-Stealth) [27" x 28" x 16"]
YFEA	Non-Coated 45° Spinal Wedge Sponge (Stealth) [24" x 13.75" x 9.5"]
YFEE	Non-Coated 45° Echocardiography Wedge Sponge (Stealth) [38.25" x 13" x 9"]
YFEM	Non-Coated Rectangle Sponge (Non-Stealth) [24" x 15" x 2.5"]
YFFD	Non-Coated 45° Spinal Body Wedge (Non-Stealth) [21" x 7" x 7"]
YMCM	Coated Medium Leg Rest with Knee Cutouts (Stealth) [1.5" x 12.5" x 7"]
YMCP	Coated Large Leg Rest with Knee Cutouts (Stealth) [24" x 18" x 10"]
YMCS	Coated Small Leg Rest with Knee Cutouts (Stealth) [18" x 14.5" x 4"]
YS-F-A01	Non-Coated Thin Rectangular Pad (Set of 2) [24" x 18" x 0.25"]
YVAM	Vinyl Covered Flat Bottom V-Trough / AP & PA Adult Head Holder Sponge [15" x 14" x 6.75"]
YVBI	Vinyl Covered 15° Wedge Sponge Set [10" x 7" x 2"]
YVBR	Vinyl Covered Rectangle Sponge [6" x 4" x 1"]
YVBT	Vinyl Covered Rectangle Sponge [6" x 4" x 2"]
YVDA	Vinyl Covered 45° Cardiac Wedge Sponge Set [28" x 14" x 14"]
YVF40	Vinyl Covered Knee Wedge Bolster Sponge [17" x 13" x 6"]
YVFA	Vinyl Covered Cylinder Bolster Sponge Set [24" x 8" x 8"]
YVFB	Vinyl Covered Semi-Cylinder Bolster Sponge [18" x 8" x 6"]
YVFC	Vinyl Covered 20° Wedge Bolster Sponge [24" x 18" x 6"]
YVFD	Vinyl Covered 45° Wedge Bolster Sponge [16" x 8" x 8"]
YVFE	Vinyl Covered 20° Incline Wedge Bolster Sponge [32" x 20" x 12"]
YVFF	Vinyl Covered 50° Incline Wedge Bolster Sponge [32" x 20" x 12"]
YVFG	Vinyl Covered Rectangle Bolster Sponge [12" x 8" x 6"]
YVFH	Vinyl Covered Rectangle Bolster Sponge [14" x 12" x 3"]
YVFJ	Vinyl Covered Rectangle Bolster Sponge [12" x 8" x 3"]
YVFK	Vinyl Covered Rectangle Bolster Sponge [20" x 13" x 3"]
YVFM	Vinyl Covered Knee Wedge Bolster Sponge [25" x 16" x 8.25"]
YVFO	Vinyl Covered 45° Spinal Wedge Bolster Sponge [21" x 7" x 7"]
YVFP	Vinyl Covered Rectangle Bolster Sponge [24" x 18" x 4"]
YVFQ	Vinyl Covered DEXA Leg Bolster Sponge [20" x 20" x 12"]
YVFU	Vinyl Covered 30°-60°-90° Wedge Sponge [24" x 10" x 6"]
YVJV	Vinyl Covered Comfort Pillow Body Wedge [25" x 16" x 8.25"]
YVJZ	Vinyl Covered Endo-Ultrasound Wedge Sponge [20" x 20" x 6"]
YVWA	Vinyl Covered Specialty Stretcher & Wheelchair Wedge Sponge [24.5" x 14" x 5.5-14"]
YVWS	Vinyl Covered Specialty Wheelchair Bolster Sponge [17" x 13" x 6"]
YX16	Closed Cell 45° Wedge Sponge [30" x 9" x 9"]
YXAA	Closed Cell Finger Block Sponge [5" x 5" x 3"]
YXAD	Closed Cell Adult Bilateral Finger Block Set (L & R) [YXFL & YXFR]
YXAJ	Closed Cell Knee Wedge Sponge [22" x 13.5" x 7"]
YXAK	Closed Cell Circular Head Sponge [Diameter: 7" x 1.5"]
YXAM	Closed Cell Flat Bottom V-Trough / AP & PA Adult Head Holder Sponge [15" x 14" x 4.625"]
YXAY	Closed Cell Specialty Angular Bolster Sponge [14" x 22.5" x 8"]
YXBB	Closed Cell Medium 45° Spinal Body Wedge Sponge [14" x 10" x 5"]
YXBC	Closed Cell 45° Wedge Sponge [10" x 7" x 5"]
YXBD	Closed Cell Large 45° Spinal Body Wedge Sponge [21" x 7" x 7"]
YXBE	Closed Cell 34° Wedge Sponge [10" x 10" x 6"]
YXBF	Closed Cell 27° Wedge Sponge [10" x 10" x 6"]
YXBG	Closed Cell 21° Wedge Sponge [10" x 10" x 4.625"]
YXBI	Closed Cell 15° Wedge Sponge Set [11" x 7" x 3"]
YXBJ	Closed Cell 12° Wedge Sponge Set [9.5" x 7.25" x 2.25"]
YXBL	Closed Cell Rectangle Sponge [10" x 7.5" x 3"]
YXBN	Closed Cell Rectangle Sponge [18" x 14" x 3"]
YXBR	Closed Cell Rectangle Sponge [6" x 4" x 1"]
YXBT	Closed Cell Rectangle Sponge [6" x 4" x 2"]
YXBU	Closed Cell 30°-60°-90° Multiangle Wedge [29.5" x 10" x 6"]
YXBV	Closed Cell Square Block Sponge [6" x 6" x 2"]
YXCA	Closed Cell Veterinary Immobilizer Trough [10" x 4" x 3"]
YXCB	Closed Cell Veterinary Immobilizer Trough [15" x 7" x 5"]
YXCC	Closed Cell Veterinary Immobilizer Trough [24" x 11" x 7"]
YXCD	Closed Cell Veterinary Immobilizer Trough [36" x 41" x 9"]
YXCM	Closed Cell Large Flat Bottom V-Trough [36" x 14" x 4.625"]
YXFL	Closed Cell Left Lateral Finger Block Sponge [6" x 6.125" x 3.25"]
YXFR	Closed Cell Right Lateral Finger Block Sponge [6" x 6.125" x 3.25"]
YXGF	Closed Cell Rectangle Sponge [12" x 10" x 2"]
YXMB	Closed Cell Rectangle Sponge [10" x 8" x 2"]
YXNZ	Closed Cell Podiatry Axial/Sesamoid Weight Bearing Sponge [13" x 8" x 4"]
YXUZ	Closed Cell Ultrasound Wedge Sponge [20" x 20" x 6"]
YXWB	Closed Cell Weight Bearing Cassette Holder [Overall Size: 17.5" x 11.5" x 4" Channel: 1.1875" x 11.5" x 3"]

GENERAL SUPPLIES & ACCESSORIES

(01-08)	Aquasonic 100 Ultrasound Transmission Gel (250ml bottle)
087	Locking Caster for BBET-03 [Must purchase with BBET-03, not sold separately]
082	Adjustable Side Rails (Pair) [Must be purchased with BBET-03, not sold separately]
145-DEF-CHAIR	Patient Defecogram Chair with Privacy Panel
24-123-205	Aluminum Bariatric Body Caliper
29602	Double Film Standard Illuminator View Box - Fluorescent Lamp
28001	Mammography Double Film Illuminator View Box - Fluorescent Lamp
29601	Single Film Standard Illuminator View Box - Fluorescent Lamp
2931-PL-10	"Caution Radiation" X-Ray Room Sign - Yellow Sign/Magenta Letters (10" x 7")
2931-PL-11	"Caution Radiation Area" X-Ray Room Sign - Yellow Sign/Magenta Letters (10" x 7")
2931-PL-12	Bilingual Pregnancy X-Ray Room Sign - Black Sign/White Letters (10" x 7")
2931-PL-13	Bilingual Pregnancy X-Ray Room Sign - Red Sign/White Letters (10" x 7")

PART NUMBER
DESCRIPTION

2931-PL-14	"Caution X-Ray In Use" Room Sign - Black Sign/White Letters (10" x 7")
2931-PL-15	"Caution X-Ray In Use" Room Sign - Red Sign/White Letters (10" x 7")
2931-PL-16	"Caution X-Ray Radiation" Room Sign - Yellow Sign/Magenta Letters (10" x 7")
302-IMC	Adjustable Seated 4-Leg Stool (Spin-Lift)
42-12	Protex Disinfectant Spray (Case of 12, 12oz bottles)
80360	Adjustable Power Exam Table
82-01	Single Bottle Premium Ultrasound Gel Warmer
82-03	Multi-Bottle Premium Ultrasound Gel Warmer
900CT	Illuminated "CT in Use" Sign
900MR	Illuminated "MRI in Use" Sign
900X-LED	Premium LED Illuminated Sign - X-Ray In Use
900X	Standard Illuminated Sign - X-Ray In Use
B311226	MRI Foam Earplugs - Yellow (Package of 1000)
BNDL-IA01	Imaging Accessory Room Bundle
BNDL-MR01	MRI Accessory Room Bundle
BNDL-ST01	Standard Imaging Room Bundle
BNDL-PR01	Premium Imaging Room Bundle
BRF-45	Rubber Tips for Step Stools (Set Of 4) [Works with BSH-65, BBS-61, BBH-69, BAS-30]
C65-11414	Single Pocket Film Jacket - Noncolor-Coded (Box of 100)
C65-11416	Double Pocket Film Jacket - Noncolor-Coded (Box of 100)
C65-11735	Standard Film Negative Preserver/Filer - Thumb Cut Access [14.5" x 17.5"] (Box of 250)
C65-11798	Standard Film Negative Preserver/Filer - Thumb Cut Access [10.5" x 12.5"] (Box of 50)
C75-21120	Standard String & Button Closure Film Mailer - Green Diamond Border [15" x 18"] (Box of 50)
C75-21613	Standard String & Button Closure Film Mailer - Clipboard [11" x 13"] (Box of 50)
C75-21984	Standard String & Button Closure Film Mailer - Clipboard [15" x 18"] (Box of 50)
CC555BLANK	Disposable Lint Free Cleaning Wipes (Package of 200)
CCC-DR	Top Fold X-Ray Panel/Receptor/Cassette Covers for CR/DR Panels - 21" x 21" (Box of 100)
CCL-14	Top Fold X-Ray Panel/Receptor/Cassette Covers for CR/DR Panels - 17.5" x 20.5" (Box of 100)
CCM-10	Top Fold X-Ray Panel/Receptor/Cassette Covers for CR/DR Panels - 12.5" x 15" (Box of 100)
CCXL-24	XL Top Fold X-Ray Panel/Receptor/Cassette Covers for CR/DR Panels - 24" x 26" (Box of 100)
CCXZ-24	XL Zip-Top Fold X-Ray Panel/Receptor/Cassette Covers for CR/DR Panels - 21" x 21" (Box of 100)
CCZ-14	Zip-Top Fold X-Ray Cassette Covers for CR/DR Panels - 17.5" x 20.5" (Box of 100)
CLEANER.KIT.	Ultimate CR/DR Panel Cleaning Bundle
FB-10W	Dosimeter Badge Holder - 10 Wide Badge Design (Wall Mountable)
FB-20W	Dosimeter Badge Holder - 20 Wide Badge Design (Wall Mountable)
FB-40W	Dosimeter Badge Holder - 40 Wide Badge Design (Wall Mountable) [Set of 2 FB-20W Holders]
GRA 203	Disposable Patient Exam Cape - Pink (30" x 21") [Box of 100]
GRA 229	Disposable Patient Exam Gown - Light Blue (30" x 42") [Box of 50]
GRA 323	Disposable Stretcher Sheets (Case of 50)
GRA 53158	Disposable Mammography Exam Cape - Blue (30" x 36") [Box of 50]
HAM2202-01	MRI Closed Hamper With Foot Pedal
HAM2203-01	Hamper Bag - 18" Drawstring Style (Single)
INM1402-01	MRI Mayo Portable Instrument Stand
IV-40	Easy Guide Economy IV Pole (4 Leg/2 Hook/Twist Lock) [46"-83" adjustable height]
IVM1307-01	MRI IV Pole (Four Hook)
LRH	Lateral Imaging Receptor Holder
LRH-B	Lateral Imaging Receptor Holder Bundle (Includes a set of TA-4 Plastic R & L Markers & a set of Marker Mates)
M-22	Standard Mayo Portable Instrument Stand
MGM400-01	SuperWand - Wireless Handheld MRI Screening Metal Detector
P13871	Sani-Cloth Alcohol-Free Surface Cleaning Wipes - 6 Canisters (160 wipes per)
P13872	Sani-Cloth Alcohol-Free Surface Cleaning Wipes - 12 Canisters (160 wipes per)
PMA-C4	Mobile Imaging Storage Tote (Royal Blue Vinyl)
Q55171	Sani-Cloth Purple-Top Super Cleaning Wipes - 6 Canisters (160 wipes per)
Q55172	Sani-Cloth Purple-Top Super Cleaning Wipes - 12 Canisters (160 wipes per)
RAM4011-01	MRI Earplug Dispenser
S-2948	Ultrasound Transducer Covers (1,000 per carton)
STM-1550-01	MRI Transport Gurney/Stretcher
TAB-L	Film Identification Stickers - Left (Blue) [250 per box]
TAB-R	Film Identification Stickers - Right (Blue) [250 per box]
TBS-2372	Standard Patient Transfer Board
TBS-ST2	Nylon Transfer Board Lifting Straps (Single pair)
WBC-1417CF	Carbon Fiber Weight Bearing Cassette/Panel/Receptor Protector
WB.C1417	Weight Bearing Cassette/Panel/Receptor Protector (Non-Tethered)

TABLE PADS

CPAD-PPC-4WY-AS	Premium Plus Radiolucent X-Ray Table Pad: 80 x 30 x 2 - Comfort Foam (4-Way Fabric) [Anti-Slip Backing]
CPAD-PPC-4WY-ST	Premium Plus Radiolucent X-Ray Table Pad: 80 x 30 x 2 - Comfort Foam (4-Way Fabric) [Standard Backing]
CPAD-PPC-BLK-AS	Premium Plus Radiolucent X-Ray Table Pad: 80 x 30 x 2 - Comfort Foam (Black Fabric) [Anti-Slip Backing]
CPAD-PPC-BLK-ST	Premium Plus Radiolucent X-Ray Table Pad: 80 x 30 x 2 - Comfort Foam (Black Fabric) [Standard Backing]
CPAD-PPC-BLU-AS	Premium Plus Radiolucent X-Ray Table Pad: 80 x 30 x 2 - Comfort Foam (Blue Fabric) [Anti-Slip Backing]
CPAD-PPC-BLU-ST	Premium Plus Radiolucent X-Ray Table Pad: 80 x 30 x 2 - Comfort Foam (Blue Fabric) [Standard Backing]
CPAD-PPF-4WY-AS	Premium Plus Radiolucent X-Ray Table Pad: 80 x 30 x 2 - Firm Foam (4-Way Fabric) [Anti-Slip Backing]
CPAD-PPF-4WY-ST	Premium Plus Radiolucent X-Ray Table Pad: 80 x 30 x 2 - Firm Foam (4-Way Fabric) [Standard Backing]
CPAD-PPF-BLK-AS	Premium Plus Radiolucent X-Ray Table Pad: 80 x 30 x 2 - Firm Foam (Black Fabric) [Anti-Slip Backing]
CPAD-PPF-BLK-ST	Premium Plus Radiolucent X-Ray Table Pad: 80 x 30 x 2 - Firm Foam (Black Fabric) [Standard Backing]
CPAD-PPF-BLU-AS	Premium Plus Radiolucent X-Ray Table Pad: 80 x 30 x 2 - Firm Foam (Blue Fabric) [Anti-Slip Backing]
CPAD-PPF-BLU-ST	Premium Plus Radiolucent X-Ray Table Pad: 80 x 30 x 2 - Firm Foam (Blue Fabric) [Standard Backing]
CPAD-PPM-4WY-AS	Premium Plus Radiolucent X-Ray Table Pad: 80 x 30 x 2 - Memory Foam (4-Way Fabric) [Anti-Slip Backing]
CPAD-PPM-4WY-ST	Premium Plus Radiolucent X-Ray Table Pad: 80 x 30 x 2 - Memory Foam (4-Way Fabric) [Standard Backing]
CPAD-PRC-4WY-AS	Premium Radiolucent X-Ray Table Pad: 72 x 23.25 x 2 - Comfort Foam (4-Way Fabric) [Anti-Slip Backing]
CPAD-PRC-4WY-ST	Premium Radiolucent X-Ray Table Pad: 72 x 23.25 x 2 - Comfort Foam (4-Way Fabric) [Standard Backing]
CPAD-PRC-BLK-AS	Premium Radiolucent X-Ray Table Pad: 72 x 23.25 x 2 - Comfort Foam (Black Fabric) [Anti-Slip Backing]
CPAD-PRC-BLK-ST	Premium Radiolucent X-Ray Table Pad: 72 x 23.25 x 2 - Comfort Foam (Black Fabric) [Standard Backing]
CPAD-PRC-BLU-AS	Premium Radiolucent X-Ray Table Pad: 72 x 23.25 x 2 - Comfort Foam (Blue Fabric) [Anti-Slip Backing]
CPAD-PRC-BLU-ST	Premium Radiolucent X-Ray Table Pad: 72 x 23.25 x 2 - Comfort Foam (Blue Fabric) [Standard Backing]
CPAD-PRF-4WY-AS	Premium Radiolucent X-Ray Table Pad: 72 x 23.25 x 2 - Firm Foam (4-Way Fabric) [Anti-Slip Backing]
CPAD-PRF-4WY-ST	Premium Radiolucent X-Ray Table Pad: 72 x 23.25 x 2 - Firm Foam (4-Way Fabric) [Standard Backing]
CPAD-PRF-BLK-AS	Premium Radiolucent X-Ray Table Pad: 72 x 23.25 x 2 - Firm Foam (Black Fabric) [Anti-Slip Backing]
CPAD-PRF-BLK-ST	Premium Radiolucent X-Ray Table Pad: 72 x 23.25 x 2 - Firm Foam (Black Fabric) [Standard Backing]

PART NUMBER	DESCRIPTION
CPAD-PRF-BLU-AS	Premium Radiolucent X-Ray Table Pad: 72 x 23.25 x 2 - Firm Foam (Blue Fabric) [Anti-Slip Backing]
CPAD-PRF-BLU-ST	Premium Radiolucent X-Ray Table Pad: 72 x 23.25 x 2 - Firm Foam (Blue Fabric) [Standard Backing]
CPAD-PRM-4WY-AS	Premium Radiolucent X-Ray Table Pad: 72 x 23.25 x 2 - Memory Foam (4-Way Fabric) [Anti-Slip Backing]
CPAD-PRM-4WY-ST	Premium Radiolucent X-Ray Table Pad: 72 x 23.25 x 2 - Memory Foam (4-Way Fabric) [Standard Backing]
PAD-SP1-BLK-NG	Standard Plus Radiolucent X-Ray Table Pad: 80 x 30 x 1 - Comfort Foam (Black) [No Grommets]
PAD-SP1-BLK-WG	Standard Plus Radiolucent X-Ray Table Pad: 80 x 30 x 1 - Comfort Foam (Black) [With Grommets]
PAD-SP1-BLU-NG	Standard Plus Radiolucent X-Ray Table Pad: 80 x 30 x 1 - Comfort Foam (Blue) [No Grommets]
PAD-SP1-BLU-WG	Standard Plus Radiolucent X-Ray Table Pad: 80 x 30 x 1 - Comfort Foam (Blue) [With Grommets]
PAD-SP1-ECO-NG	Economy Standard Plus Radiolucent X-Ray Table Pad: 80 x 30 x 1 - Comfort Foam [No Grommets]
PAD-SP1-ECO-WG	Economy Standard Plus Radiolucent X-Ray Table Pad: 80 x 30 x 1 - Comfort Foam [With Grommets]
PAD-SP1-TBK-NG	Standard Plus Radiolucent X-Ray Table Pad: 80 x 30 x 1 - Comfort Foam (Techno-Tuff Black) [No Grommets]
PAD-SP1-TBK-WG	Standard Plus Radiolucent X-Ray Table Pad: 80 x 30 x 1 - Comfort Foam (Techno-Tuff Black) [With Grommets]
PAD-SP2-BLK-NG	Standard Plus Radiolucent X-Ray Table Pad: 80 x 30 x 2 - Firm Foam (Black) [No Grommets]
PAD-SP2-BLK-WG	Standard Plus Radiolucent X-Ray Table Pad: 80 x 30 x 2 - Firm Foam (Black) [With Grommets]
PAD-SP2-BLU-NG	Standard Plus Radiolucent X-Ray Table Pad: 80 x 30 x 2 - Firm Foam (Blue) [No Grommets]
PAD-SP2-BLU-WG	Standard Plus Radiolucent X-Ray Table Pad: 80 x 30 x 2 - Firm Foam (Blue) [With Grommets]
PAD-SP2-ECO-NG	Economy Standard Plus Radiolucent X-Ray Table Pad: 80 x 30 x 2 - Firm Foam [No Grommets]
PAD-SP2-ECO-WG	Economy Standard Plus Radiolucent X-Ray Table Pad: 80 x 30 x 2 - Firm Foam [With Grommets]
PAD-SP2-TBK-NG	Standard Plus Radiolucent X-Ray Table Pad: 80 x 30 x 2 - Firm Foam (Techno-Tuff Black) [No Grommets]
PAD-SP2-TBK-WG	Standard Plus Radiolucent X-Ray Table Pad: 80 x 30 x 2 - Firm Foam (Techno-Tuff Black) [With Grommets]
PAD-ST1-BLK-NG	Standard Radiolucent X-Ray Table Pad: 72 x 23.25 x 1 - Comfort Foam (Black) [No Grommets]
PAD-ST1-BLK-WG	Standard Radiolucent X-Ray Table Pad: 72 x 23.25 x 1 - Comfort Foam (Black) [With Grommets]
PAD-ST1-BLU-NG	Standard Radiolucent X-Ray Table Pad: 72 x 23.25 x 1 - Comfort Foam (Blue) [No Grommets]
PAD-ST1-BLU-WG	Standard Radiolucent X-Ray Table Pad: 72 x 23.25 x 1 - Comfort Foam (Blue) [With Grommets]
PAD-ST1-ECO-NG	Economy Standard Radiolucent X-Ray Table Pad: 72 x 23.25 x 1 - Comfort Foam [No Grommets]
PAD-ST1-ECO-WG	Economy Standard Radiolucent X-Ray Table Pad: 72 x 23.25 x 1 - Comfort Foam [With Grommets]
PAD-ST1-TBK-NG	Standard Radiolucent X-Ray Table Pad: 72 x 23.25 x 1 - Comfort Foam (Techno-Tuff Black) [No Grommets]
PAD-ST1-TBK-WG	Standard Radiolucent X-Ray Table Pad: 72 x 23.25 x 1 - Comfort Foam (Techno-Tuff Black) [With Grommets]
PAD-ST2-BLK-NG	Standard Radiolucent X-Ray Table Pad: 72 x 23.25 x 2 - Firm Foam (Black) [No Grommets]
PAD-ST2-BLK-WG	Standard Radiolucent X-Ray Table Pad: 72 x 23.25 x 2 - Firm Foam (Black) [With Grommets]
PAD-ST2-BLU-NG	Standard Radiolucent X-Ray Table Pad: 72 x 23.25 x 2 - Firm Foam (Blue) [No Grommets]
PAD-ST2-BLU-WG	Standard Radiolucent X-Ray Table Pad: 72 x 23.25 x 2 - Firm Foam (Blue) [With Grommets]
PAD-ST2-ECO-NG	Economy Standard Radiolucent X-Ray Table Pad: 72 x 23.25 x 2 - Firm Foam [No Grommets]
PAD-ST2-ECO-WG	Economy Standard Radiolucent X-Ray Table Pad: 72 x 23.25 x 2 - Firm Foam [With Grommets]
PAD-ST2-TBK-NG	Standard Radiolucent X-Ray Table Pad: 72 x 23.25 x 2 - Firm Foam (Techno-Tuff Black) [No Grommets]
PAD-ST2-TBK-WG	Standard Radiolucent X-Ray Table Pad: 72 x 23.25 x 2 - Firm Foam (Techno-Tuff Black) [With Grommets]
PAD-VS1-BLK-NG	Standard Veterinary Radiolucent X-Ray Table Pad: 58 x 30 x 1 - (Black Vinyl) [No Grommets]
PAD-VL1-BLK-NG	Large Veterinary Radiolucent X-Ray Table Pad: 65 x 30 x 1 - (Black Vinyl) [No Grommets]

X-RAY MARKERS

124	Nipple Artifact Markers (Pack of 100)
ES-25-11	Flexible Image Scaling Device (Single 25mm Sphere Marker included)
M31G100_25_PK5	Replacement 25mm Sphere Markers (5 individual spheres) [for A25DR]
MM3007	Specialty CT & MRI Skin Markers (Package of 50)
SDG-M612	Mammography Skin Mole Markers - 0.5" (100 Markers)
SDG-MSD3	Digital Breast Tomosynthesis Mammography Skin Mole Markers [2D/3D] (Box Of 100)
SDM-A1	Skin Arrow Markers - 7.0mm (100 Arrows)
SDM-BB15	Skin Dot Markers - 1.5mm (100 Dots)
SDM-BB20	Skin Dot Markers - 2.0mm (100 Dots)
SDM-BB25	Skin Dot Markers - 2.5mm (100 Dots)
SDM-BB30	Skin Dot Markers - 3.0mm (50 Dots)
SDM-BB40	Skin Dot Markers - 4.0mm (50 Dots)
SDM-BB50	Skin Dot Markers - 5.0mm (50 Dots)
SDM-CT1	CT Non-Metallic Skin Dot Markers - 2.3mm (50 Dots)
SDM-CT2	CT Non-Metallic Skin Dot Markers - 4.0mm (50 Dots)
SDW-SS612	Skin-Line Markers - 1.0mm (100 Markers)
TA-EAL000	Aluminum Arrow (1") Multi-Directional Marker - No Characters [Single]
TA-EAL003	Aluminum Left Only (1/2") Vertical Marker - with 3 Character Max
TA-EAL003-625	Aluminum Left Only (5/8") Vertical Marker - with 3 Character Max
TA-EAL001	Aluminum Left Only (5/8") Vertical Marker - No Characters
TA-EAL011	Aluminum Left Only (1") Vertical Marker - No Characters
TA-EAL013	Aluminum Left Only (1") Vertical Marker - with 3 Character Max
TA-EAL013-2	Aluminum Left Only (1") Vertical Marker - 2 Lines with 3 Character Max
TA-EAL021	Aluminum Left Only (1/2") Horizontal Marker - No Characters
TA-EAL032	Aluminum Left Only (1/2") Horizontal Marker - with 3 Character Max
TA-EAL041	Aluminum Left Only (1/2") with Arrow (1") Horizontal Marker - No Characters
TA-EAL043	Aluminum Left Only (1/2") with Arrow (1") Horizontal Marker - with 3 Character Max
TA-EAOP01	Aluminum Right & Left (3/4") Oncology/Therapy Vertical Marker - No Characters [Set]
TA-EAP001	Aluminum Right & Left (5/8") Vertical Marker - No Characters [Set]
TA-EAP003	Aluminum Right & Left (1/2") Vertical Marker Set - with 3 Character Max
TA-EAP003-625	Aluminum Right & Left (5/8") Vertical Marker - with 3 Character Max [Set]
TA-EAP011	Aluminum Right & Left (1") Vertical Marker - No Characters [Set]
TA-EAP013	Aluminum Right & Left (1") Vertical Marker - with 3 Character Max [Set]
TA-EAP013-2	Aluminum Right & Left (5/8") Vertical Marker - 2 Lines with 3 Character Max [Set]
TA-EAP021	Aluminum Right & Left (1/2") Horizontal Marker - No Characters [Set]
TA-EAP032	Aluminum Right & Left (1/2") Horizontal Marker - with 3 Character Max [Set]
TA-EAP041	Aluminum Right & Left (1/2") with Arrow (1") Horizontal Marker - No Characters [Set]
TA-EAP043	Aluminum Right & Left (1/2") with Arrow (1") Horizontal Marker - with 3 Character Max [Set]
TA-EAR001	Aluminum Right Only (5/8") Vertical Marker - No Characters
TA-EAR003	Aluminum Right Only (1/2") Vertical Marker - with 3 Character Max
TA-EAR003-625	Aluminum Right Only (5/8") Vertical Marker - with 3 Character Max
TA-EAR011	Aluminum Right Only (1") Vertical Marker - No Characters
TA-EAR013	Aluminum Right Only (1") Vertical Marker - with 3 Character Max
TA-EAR013-2	Aluminum Right Only (1") Vertical Marker - 2 Lines with 3 Character Max
TA-EAR021	Aluminum Right Only (1/2") Horizontal Marker - No Characters
TA-EAR032	Aluminum Right Only (1/2") Horizontal Marker - with 3 Character Max
TA-EAR041	Aluminum Right Only (1/2") with Arrow (1") Horizontal Marker - No Characters
TA-EAR043	Aluminum Right Only (1/2") with Arrow (1") Horizontal Marker - with 3 Character Max
TA-EAW001	Aluminum Word Horizontal Marker - 1 Character Max (3/8") [Single]
TA-EAW002	Aluminum Word Horizontal Marker - 2 Character Max (3/8") [Single]

PART NUMBER
DESCRIPTION

TA-EAW003	Aluminum Word Horizontal Marker - 3 Character Max (3/8") [Single]
TA-EAW004	Aluminum Word Horizontal Marker - 4 Character Max (3/8") [Single]
TA-EAW005	Aluminum Word Horizontal Marker - 5 Character Max (3/8") [Single]
TA-EAW006	Aluminum Word Horizontal Marker - 6 Character Max (3/8") [Single]
TA-EAW007	Aluminum Word Horizontal Marker - 7 Character Max (3/8") [Single]
TA-EAW008	Aluminum Word Horizontal Marker - 8 Character Max (3/8") [Single]
TA-EAW009	Aluminum Word Horizontal Marker - 9 Character Max (3/8") [Single]
TA-EAW010	Aluminum Word Horizontal Marker - 10 Character Max (3/8") [Single]
TA-EAW01	Aluminum Word Horizontal Marker - 1 Character Max (1/2") [Single]
TA-EAW011	Aluminum Word Horizontal Marker - 11 Character Max (3/8") [Single]
TA-EAW012	Aluminum Word Horizontal Marker - 12 Character Max (3/8") [Single]
TA-EAW013	Aluminum Word Horizontal Marker - 13 Character Max (3/8") [Single]
TA-EAW02	Aluminum Word Horizontal Marker - 2 Character Max (1/2") [Single]
TA-EAW03	Aluminum Word Horizontal Marker - 3 Character Max (1/2") [Single]
TA-EAW04	Aluminum Word Horizontal Marker - 4 Character Max (1/2") [Single]
TA-EAW05	Aluminum Word Horizontal Marker - 5 Character Max (1/2") [Single]
TA-EAW06	Aluminum Word Horizontal Marker - 6 Character Max (1/2") [Single]
TA-EAW07	Aluminum Word Horizontal Marker - 7 Character Max (1/2") [Single]
TA-EAW08	Aluminum Word Horizontal Marker - 8 Character Max (1/2") [Single]
TA-EAW09	Aluminum Word Horizontal Marker - 9 Character Max (1/2") [Single]
TA-EAW10	Aluminum Word Horizontal Marker - 10 Character Max (1/2") [Single]
TA-EPA1000	Plastic Arrow (1") Multi-Directional Marker - No Characters [Single]
TA-EPL001	Plastic Left Only (5/8") Compact Square Vertical Marker - No Characters [Set]
TA-EPL002	Plastic Left Only (5/8") Compact Square Vertical Marker - with 3 Character Max
TA-EPL003	Plastic Left Only (5/8") Vertical Marker - with 3 Character Max
TA-EPL003-2	Plastic Left Only (5/8") Vertical Marker - 2 Lines with 3 Character Max
TA-EPL004	Plastic Left Only (5/8") Vertical Marker - No Characters
TA-EPL011	Plastic Left Only (1") Vertical Marker - No Characters
TA-EPL013	Plastic Left Only (1") Vertical Marker - with 3 Character Max
TA-EPL021	Plastic Left Only (1/2") Horizontal Marker - No Characters
TA-EPL032	Plastic Left Only (1/2") Horizontal Marker - With 3 Character Max [Set]
TA-EPP001	Plastic Right & Left (5/8") Compact Square Vertical Marker - No Characters [Set]
TA-EPP002	Plastic Right & Left (5/8") Compact Square Vertical Marker - with 3 Character Max [Set]
TA-EPP003	Plastic Right & Left (5/8") Vertical Marker - with 3 Character Max [Set]
TA-EPP004	Plastic Right & Left (5/8") Vertical Marker - No Characters [Set]
TA-EPP011	Plastic Right & Left (1") Vertical Marker - No Characters [Set]
TA-EPP013	Plastic Right & Left (1") Vertical Marker - with 3 Character Max [Set]
TA-EPP013-2	Plastic Right & Left (5/8") Vertical Marker - 2 Lines with 3 Character Max [Set]
TA-EPP021	Plastic Right & Left (1/2") Horizontal Marker - No Character [Set]
TA-EPP032	Plastic Right & Left (1/2") Horizontal Marker - With 3 Character Max [Set]
TA-EPR001	Plastic Right Only (5/8") Compact Square Vertical Marker - No Characters [Set]
TA-EPR002	Plastic Right Only (5/8") Compact Square Vertical Marker - with 3 Character Max
TA-EPR003	Plastic Right Only (5/8") Vertical Marker - with 3 Character Max
TA-EPR003-2	Plastic Right Only (5/8") Vertical Marker - 2 Lines with 3 Character Max
TA-EPR004	Plastic Right Only (5/8") Vertical Marker - No Characters
TA-EPR011	Plastic Right Only (1") Vertical Marker - No Characters
TA-EPR013	Plastic Right Only (1") Vertical Marker - with 3 Character Max
TA-EPR021	Plastic Right Only (1/2") Horizontal Marker - No Characters
TA-EPR032	Plastic Right Only (1/2") Horizontal Marker - With 3 Character Max [Se
TA-EPW001	Plastic Word Horizontal Marker - 1 Character Max (3/8") [Single]
TA-EPW002	Plastic Word Horizontal Marker - 2 Character Max (3/8") [Single]
TA-EPW003	Plastic Word Horizontal Marker - 3 Character Max (3/8") [Single]
TA-EPW004	Plastic Word Horizontal Marker - 4 Character Max (3/8") [Single]
TA-EPW005	Plastic Word Horizontal Marker - 5 Character Max (3/8") [Single]
TA-EPW006	Plastic Word Horizontal Marker - 6 Character Max (3/8") [Single]
TA-EPW007	Plastic Word Horizontal Marker - 7 Character Max (3/8") [Single]
TA-EPW01	Plastic Word Horizontal Marker - 1 Character Max (1/2") [Single]
TA-EPW010	Plastic Word Horizontal Marker - 10 Character Max (3/8") [Single]
TA-EPW011	Plastic Word Horizontal Marker - 11 Character Max (3/8") [Single]
TA-EPW012	Plastic Word Horizontal Marker - 12 Character Max (3/8") [Single]
TA-EPW013	Plastic Word Horizontal Marker - 13 Character Max (3/8") [Single]
TA-EPW02	Plastic Word Horizontal Marker - 2 Character Max (1/2") [Single]
TA-EPW03	Plastic Word Horizontal Marker - 3 Character Max (1/2") [Single]
TA-EPW04	Plastic Word Horizontal Marker - 4 Character Max (1/2") [Single]
TA-EPW05	Plastic Word Horizontal Marker - 5 Character Max (1/2") [Single]
TA-EPW10	Plastic Word Horizontal Marker - 10 Character Max (1/2") [Single]
TA-HBM016	Wall Mounted Marker Storage Board (16 Pegs)
TA-MRKSTK	Marker Mates - Reusable Marker Adhesives (Set)
TA-PAL01-V	Aluminum Left Only (5/8") Position Indicator Vertical Marker - No Characters
TA-PAL03-H	Aluminum Left Only (1/2") Position Indicator Horizontal Marker - with 3 Character Max
TA-PAL03-V	Aluminum Left Only (5/8") Position Indicator Vertical Marker - with 3 Character Max
TA-PAL03-V-2	Aluminum Left Only (5/8") Position Indicator Vertical Marker - 2 Lines with 3 Character Max
TA-PAP01-V	Aluminum Right & Left (5/8") Position Indicator Vertical Marker - No Characters [Set]
TA-PAP03-H	Aluminum Right & Left (1/2") Position Indicator Horizontal Marker - with 3 Character Max [Set]
TA-PAP03-V	Aluminum Right & Left (5/8") Position Indicator Vertical Marker - with 3 Character Max [Set]
TA-PAP03-V-2	Aluminum Right & Left (5/8") Position Indicator Vertical Marker - 2 Lines with 3 Character Max [Set]
TA-PAR01-V	Aluminum Right Only (5/8") Position Indicator Vertical Marker - No Characters
TA-PAR03-H	Aluminum Right Only (1/2") Position Indicator Horizontal Marker - with 3 Character Max
TA-PAR03-V	Aluminum Right Only (5/8") Position Indicator Vertical Marker - with 3 Character Max
TA-PAR03-V-2	Aluminum Right Only (5/8") Position Indicator Vertical Marker - 2 Lines with 3 Character Max
TA-PPL01-V	Plastic Left Only Compact Square Vertical Position Indicator Marker - No Characters
TA-PPL03-V	Plastic Left Only Vertical Position Indicator Marker - 2 Character Max
TA-PPL11-V	Plastic Left (5/8") Position Indicator Vertical Marker - No Characters
TA-PPL13-V	Plastic Left Only (5/8") Position Indicator Vertical Marker - with 3 Character Max
TA-PPP01-V	Plastic Right & Left Compact Square Vertical Position Indicator Marker - No Characters [Set]
TA-PPP03-V	Plastic Right & Left Vertical Position Indicator Marker - 2 Character Max [Set]
TA-PPP11-V	Plastic Right & Left (5/8") Position Indicator Vertical Marker - No Characters [Set]
TA-PPP13-V	Plastic Right & Left (5/8") Position Indicator Vertical Marker Set - with 3 Character Max [Set]
TA-PPR01-V	Plastic Right Only Compact Square Vertical Position Indicator Marker - No Characters
TA-PPR03-V	Plastic Right Only Vertical Position Indicator Marker - 2 Character Max
TA-PPR11-V	Plastic Right (5/8") Position Indicator Vertical Marker - No Characters
TA-PPR13-V	Plastic Right Only (5/8") Position Indicator Vertical Marker - with 3 Character Max

THE
ONE-STOP-SHOP
FOR IMAGING ACCESSORIES



TECHNO-AIDE, Inc. 7532 Hickory Hills Ct., Whites Creek, TN USA 37189
(800)251-2629 | (615)350-7030 | customerservice@techno-aide.com
For more information, please visit techno-aide.com
Order requests to orders@techno-aide.com